

O P E R A T I N G A N D S E R V I C E M A N U A L

MODEL 4260A
UNIVERSAL BRIDGE

SERIALS PREFIXED : 1214J

See Section VII for Other Serial Prefixes.

PART No. 04260-99004

Printed : MAR 1973

HEWLETT  PACKARD

1
2
3
4
5
6
7
8
9
10
11
12
13
14
15
16
17
18
19
20
21
22
23
24
25
26
27
28
29
30
31
32
33
34
35
36
37
38
39
40
41
42
43
44
45
46
47
48
49
50
51
52
53
54
55
56
57
58
59
60
61
62
63
64
65
66
67
68
69
70
71
72
73
74
75
76
77
78
79
80
81
82
83
84
85
86
87
88
89
90
91
92
93
94
95
96
97
98
99
100

TABLE OF CONTENTS

Section	Page
I GENERAL INFORMATION	1-1
1-1. Description	1-1
1-4. Terminology	1-1
1-6. Instrument Identification	1-1
1-8. Applications	1-1
1-10. Specifications	1-1
1-12. Auxiliary Equipment Required	1-1
II INSTALLATION	2-1
2-1. Introduction	2-1
2-3. Unpacking and Inspection	2-1
2-5. Storage and Shipment	2-1
2-11. Operation from 115 or 230 Volts.	2-3
2-13. 3-Conductor Power Cable	2-3
III OPERATION	3-1
3-1. Introduction	3-1
3-3. Turn-On Procedure	3-1
3-5. Use of the DQ Vernier	3-1
3-7. Dc Resistance Measurements	3-1
3-8. Power Considerations	3-1
3-10. Measurements	3-1
3-16. Capacitance Measurements	3-3
3-17. Introduction	3-3
3-19. Residual Capacitance.	3-3
3-21. Cs and Cp Measurement Differences	3-4
3-23. Measurement Procedure	3-4
3-25. Voltage Across Unknown C	3-5
3-27. Influence of D in Cp Auto Measurement	3-5
3-29. Inductance Measurements	3-5
3-30. Introduction	3-5
3-32. Residual Inductance	3-5
3-34. Ls and Lp Measurement Differences	3-5
3-36. Measurement Procedure	3-6
3-40. Influence of Q in Ls Auto Measurement	3-6
3-42. Special Measurements	3-6
3-43. 20 Hz to 20 kHz Measurements	3-6
3-46. Operation with External Generator.	3-7
3-48. Influence of Residual and Lead Impedances	3-8
3-50. D and Q Measurements	3-8
3-54. C Measurements with DC Bias	3-8
3-57. L Measurements with DC Bias	3-9
IV THEORY OF OPERATION	4-1
4-1. Introduction	4-1
4-3. Description	4-1
4-4. General	4-1
4-6. Block Diagram	4-1
4-9. Basic Bridge for Resistance Measurements	4-1
4-11. Basic Circuits for Capacitance Measurements	4-1
4-13. Basic Circuits for Inductance Measurements.	4-1
4-15. Range and Function Switch A100	4-1
4-18. Power Supply and 1 kHz Oscillator A200	4-3
4-20. Power Supply.	4-3
4-26. 1 kHz Oscillator.	4-3
4-28. Reference Voltage A300	4-3
4-29. Introduction	4-3
4-31. Reference Phase Circuits	4-3
4-34. Variable Phase Circuits	4-4
4-37. Phase Comparator	4-4
4-40. Miller Integrator	4-4
4-42. Switch	4-4

TABLE OF CONTENTS

IV	THEORY OF OPERATION (cont'd)	4-4
	4-44. Detector Assembly A400	4-4
	4-45. Introduction	4-4
	4-47. Error Signal Amplifier	4-4
	4-50. One-Shot Multivibrator	4-4
	4-53. Phase Detector	4-5
	4-57. Differential Amplifier and Miller Integrator	4-5
	4-59. Variable Resistance Circuit	4-5
	4-62. Differential Amplifier and Lamp Driver	4-5
	4-64. Chassis Assembly A500	4-6
	4-66. Decimal Point and Direction Indicator Lamp A600	4-6
V	MAINTENANCE	5-1
	5-1. Introduction	5-1
	5-3. Test Equipment	5-1
	5-5. Instrument Cover Removal	5-1
	5-7. Assembly Identification	5-1
	5-9. Performance Check	5-1
	5-11. Troubleshooting	5-5
	5-14. Repair	5-5
	5-15. Cover and Front Panel Removal	5-5
	5-17. Printed Circuit Component Replacement	5-5
	5-19. CRL Counter and R3 Replacement	5-5
	5-22. DQ Dial and R5 Replacement	5-5
	5-24. Adjustments	5-5
	5-29. Bridge Circuit Component Checks	5-8
	5-39. Operation Checks of Printed Circuit Assemblies	5-12
	5-41. Power Supply and 1 kHz Oscillator Assy A100	5-12
	5-44. Reference Voltage Assembly A300	5-12
	5-46. Detector Assembly A400	5-12
VI	REPLACEABLE PARTS	6-1
	6-1. Introduction	6-1
	6-2. Ordering Information	6-1
VII	MANUAL CHANGES AND OPTIONS	7-1
	7-1. Options	7-1
	7-3. Special Instruments	7-1
	7-5. Manual Changes	7-1
	7-7. Later Instruments	7-1
	7-8. Earlier Instruments (Backdating Changes)	7-1
VIII	CIRCUIT DIAGRAMS	8-1
	8-1. Introduction	8-1

LIST OF TABLES

Table		
1-1.	Specifications	1-2
3-1.	Correction Terms for Residual Lead Errors	3-4
4-1.	Assembly Designations	4-1
5-1.	Performance Check Test Equipment	5-1
5-2.	Performance Checks	5-2
5-3.	Test Equipment Required for Troubleshooting	5-6
5-4.	Trouble Symptoms and Possible Causes	5-6
5-5.	Decimal Point and Units Indication Logic	5-8
5-6.	Test Equipment for Bridge Circuit Checks	5-9
6-1.	Reference Designation Index	6-3
6-2.	Replaceable Parts	6-11
6-3.	Manufacturer's Code List	6-15
7-1.	Manual Backdating Changes	7-1

LIST OF ILLUSTRATIONS

Figure	Page
1-1. Model 4260A and Accessory	1-0
2-1. Adapter Frame	2-1
2-2. Combining Case	2-2
3-1. Front and Rear Panel Controls, Indicators and Connectors	3-2
3-2. Capacitance and Inductance Errors in AUTO vs D & Q	3-5
3-3. Operation with External Generator	3-7
3-4. DQ Range vs Frequency	3-8
3-5. Dc Biased Capacitance Measurement	3-9
3-6. Dc Biased Inductance Measurement	3-9
4-1. Basic Bridge Circuits	4-2
4-2. CRL Light Control	4-5
5-1. Capacitance and D Accuracy Check	5-2
5-2. Internal Oscillator Check	5-4
5-3. Right and Left Side Internal Component Location	5-7
5-4. Error Signal Amplifier Phase and Gain Test Setup	5-8
5-5. Test Setup for Adjustments	5-11
5-6. Resistance Network for Checks	5-12
5-7. Top and Bottom Internal Component Location	5-13
6-1. Modular Cabinet Parts	6-2
8-1. Schematic Diagram Notes	8-2
8-2. Overall Block Diagram	8-3
8-3. Range and Function Switch A100, Decimal Point and Direction Light A600, Component Location and Schematic Diagram	8-5
8-4. Power Supply and 1 kHz Oscillator A200, Component Location and Schematic Diagram	8-7
8-5. Reference Voltage Assembly A300, Component Location and Schematic Diagram	8-9
8-6. Detector Assembly A400, Component Location and Schematic Diagram	8-11



MODEL 4260A

POWER CORD

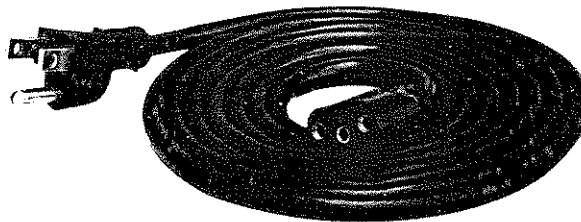

Figure 1-1. Model 4260A and Accessory

02337-1

SECTION I

GENERAL INFORMATION

1-1. DESCRIPTION.

1-2. The YHP Model 4260A Universal Bridge (Figure 1-1) makes fast, easy measurements of resistance (R), capacitance (C), inductance (L), capacitor dissipation factor (D), or inductance quality factor (Q). The instrument includes five bridge circuits, selected by the FUNCTION switch, as well as the detector and 1 kHz oscillator necessary for dc and ac measurements. For measurements at frequencies other than 1 kHz, an external oscillator must be used.

1-3. Front panel controls select the measurement function and range, with R, L, and C values displayed with four-digit resolution on an in-line, digital counter. Q and D values are displayed on a dial with a red hairline indicating the measured value. The auto-balance circuit and an easy-to-read meter reduce the time required for measuring low Q or high D components. Correct decimal point location is automatic and direction lights indicate which way the CRL control should be rotated for the measurement.

1-4. TERMINOLOGY.

1-5. The definitions of the following terms apply as they are used throughout this manual.

a. RESIDUAL (inductance or capacitance): distributed inductance or capacitance always present at UNKNOWN terminals.

b. DISSIPATION FACTOR (D): loss factor for capacitors (equal to reciprocal of Q).

c. QUALITY FACTOR (Q): figure of merit for inductors (equal to reciprocal of D).

d. Cs: represents equivalent circuit of capacitor in series with resistor.

e. Cp: represents equivalent circuit of capacitor in parallel with resistor.

f. Ls: represents equivalent circuit of inductor in series with resistor.

g. Lp: represents equivalent circuit of inductor in parallel with resistor.

h. AUTO NULL: eliminates DQ manual control; direction for null is automatically indicated for Cp and Ls measurements.

1-6. INSTRUMENT IDENTIFICATION.

1-7. Hewlett-Packard uses a two-section, eight-digit serial number (000-00000). The first three digits (serial prefix) identify a series of instruments; the last five digits identify a particular instrument in that series. If the serial prefix on the rear panel of your instrument does not agree with the serial prefix on the title page of this manual, there are differences between your instrument and the one described in this manual which are explained in the insert sheet supplied with the manual. If the insert sheet is missing, the information can be supplied by your nearest Hewlett-Packard field office (addresses are listed at the back of this manual).

1-8. APPLICATIONS.

1-9. The Model 4260A makes quick, easy measurements of R, L, C, D, or Q characteristics of passive electronic components. R, L, and C measurements are made with 3- or 4-digit resolution. With external null voltmeter, accurate measurements are possible for milliohms or megohms. The instrument is readily portable (accessory carrying handle, HP 11057A, can be easily attached without screws).

1-10. SPECIFICATIONS.

1-11. Table 1-1 lists all technical specifications for the Model 4260A Universal Bridge. Figure 3-4 shows DQ range versus frequency characteristics.

1-12. AUXILIARY EQUIPMENT REQUIRED.

1-13. External dc null millivoltmeter (such as the HP Model 413A) is recommended for accurate R measurements below 100 ohms and above 10 kilohms. External generator (such as HP Model 200 CD) with 2 volt output and 600 ohms output impedance is required for 20 Hz to 20 kHz measurements. External tuned null detector with 90 dB gain and input impedance greater than 10 kilohms or oscilloscope with $100 \mu\text{V}/\text{cm}$ sensitivity is recommended for the measurement with external generator.

Table 1-1. Specifications

CAPACITANCE MEASUREMENT

CAPACITANCE

Range: 1 pF to 1000 μ F, in 7 ranges.

Accuracy:

$\pm (1\% + 1 \text{ Digit})$, from 1 nF to 100 μ F.

$\pm (2\% + 1 \text{ Digit})$, from 1 pF to 1 nF and 100 μ F to 1000 μ F.

Residual capacitance $\approx 2 \text{ pF}$.

DISSIPATION FACTOR

Range:

LOW D - - - D (of series C): 0.001 to 0.12.

HIGH D - - - D (of parallel C): 0.05 to 50.

Accuracy: for C > 100 pF.

LOW D -- $\pm \frac{2}{\sqrt{D \text{ of Reading}}} \%$.

HIGH D -- $\pm (10 D \text{ of Reading} + 4) \%$
 $- (10 \sqrt{D \text{ of Reading}} + 2) \%$.

(C greater than 100 pF and at 1 kHz; an additional error \pm ONE DIAL DIVISION is required at frequencies other than 1 kHz.)

INDUCTANCE MEASUREMENT

INDUCTANCE

Range: 1 μ H to 1000 H, in 7 ranges.

Accuracy:

$\pm (1\% + 1 \text{ Digit})$, from 1 mH to 100 H.

$\pm (2\% + 1 \text{ Digit})$, from 1 μ H to 1000 H.

Residual inductance $\leq 1 \mu$ H.

QUALITY FACTOR

Range:

LOW Q - - - Q (of series L): 0.02 to 20.

HIGH Q - - - Q (of parallel L): 8 to 1000.

Accuracy: for L > 100 μ H.

LOW Q -- $\pm \left(\frac{10}{Q \text{ of Reading}} + 4 \right) \%$.

$- \left(\frac{10}{\sqrt{Q \text{ of Reading}}} + 2 \right) \%$.

HIGH Q -- $\pm 2 \sqrt{Q \text{ of Reading}} \%$.

(L greater than 100 μ H and at 1 kHz; an additional error \pm ONE DIAL DIVISION is required at frequencies other than 1 kHz.)

RESISTANCE MEASUREMENT

RESISTANCE

Range: 10 milliohms to 10 megohms, in 7 ranges.

Accuracy:

$\pm (1\% + 1 \text{ Digit})$, from 10 ohms to 1 megohm.

$\pm (2\% + 1 \text{ Digit})$, from 10 milliohms to 10 ohms and 1 megohm to 10 megohms.

Residual resistance ≈ 3 milliohms.

Resistance measurements at DC only.

ELECTRONIC AUTO NULL

Eliminates need for DQ adjustments in parallel C and series L measurements at 1 kHz.

Accuracy (when D ≤ 1 , Q ≥ 1 and CL measurements are made in 3 and 4 figures) equals [normal operating condition $\pm 0.5\%$].

AUTOMATIC NULL DIRECTION INDICATOR

Direction of the CRL control rotation required for the bridge null is automatically indicated by the front panel indicator lights.

OSCILLATOR AND DETECTOR

INTERNAL OSCILLATOR: 1 kHz $\pm 2\%$, 100 mV rms $\pm 20\%$.

INTERNAL DC SUPPLY: Less than 40 volts at nominal AC line voltage.

INTERNAL DETECTOR: Tuned amplifier at 1 kHz; functions as a preamplifier for measurements with external generator.

EXTERNAL OSCILLATOR: 20 Hz to 20 kHz measurements of capacitance, inductance, dissipation factor and quality factor are possible with external oscillator (range will be a function of applied frequency).

GENERAL

DC BIAS:

Voltage: Up to 6V at AUTO.

Up to 35V at MANUAL.

Current: Up to 10 mA.

POWER SUPPLY: 115 or 230 volts $\pm 10\%$, 50 or 60 Hz, approx. 7 watts.

DIMENSIONS:

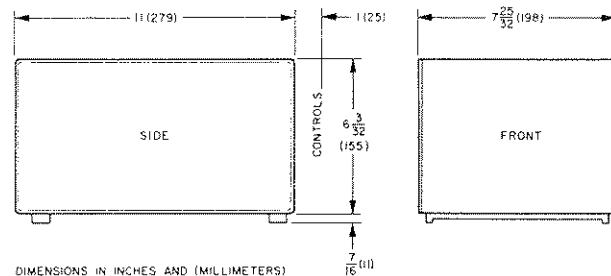

WEIGHT:

Net, 11 lbs. (5 kg).

Shipping, 15 lbs. (6, 8 kg).

ACCESSORY SUPPLIED: 7 ft. power cable with NEMA plug.

EQUIPMENT AVAILABLE:

18-pin printed circuit extender board 5060-2041

15-pin printed circuit extender board 5060-0049

DC Null Voltmeter, HP Model 413A

20 Hz to 20 kHz Oscillator, HP Model 200CD

Oscilloscope, HP Model 140A

SECTION II INSTALLATION

2-1. INTRODUCTION.

2-2. This section of the manual contains information for unpacking, inspection, repackaging, storage, and installation of the Model 4260A.

2-3. UNPACKING AND INSPECTION.

2-4. If the shipping carton is damaged, ask that the carrier's agent be present when the instrument is unpacked. Inspect the instrument for damage (scratches, dents, broken knobs, etc.) If the instrument is damaged or fails to meet specifications (Performance Check, Paragraph 5-9), notify the carrier and the nearest Hewlett-Packard field office (see list at back of this manual). Retain the shipping carton and the padding material for the carrier's inspection. The field office will arrange for the repair or replacement of your instrument without waiting for the claim against the carrier to be settled.

2-5. STORAGE AND SHIPMENT.

2-6. PACKAGING. To protect valuable electronic equipment during storage or shipment always use the best packaging methods available. Your Hewlett-Packard field office can provide packing material such as that used for original factory packaging. Contract packaging companies in many cities can provide dependable custom packaging on short notice. Here are two recommended packaging methods:

a. RUBBERIZED HAIR. Cover painted surfaces of instrument with protective wrapping paper. Pack instrument securely in strong corrugated container (350 lb/sq in. bursting test) with 2-inch rubberized hair pads placed along all surfaces of the instrument. Insert fillers between pads and container to ensure a snug fit. Mark the box "Delicate Instrument" and seal with strong tape or metal bands.

b. EXCELSIOR. Cover painted surfaces of instrument with protective wrapping paper. Pack instrument in strong corrugated container (350 lb/sq in. bursting test) with a layer of excelsior about 6 inches thick packed firmly against all surfaces of the instrument. Mark the box "Delicate Instrument" and seal with strong tape or metal bands.

2-7. ENVIRONMENT. Temperature during storage and shipment should be limited as follows:

- a. Minimum temperature -40°C (-40°F).
- b. Maximum temperature $+75^{\circ}\text{C}$ ($+167^{\circ}\text{F}$).

2-8. The Model 4260A is equipped with plastic feet and tilt stand for bench operation as shipped from the factory. When the instrument is to be rack mounted, a combining case (Paragraph 2-9) or adapter frame (Paragraph 2-10) is required. These items are avail-

able through your Hewlett-Packard Sales/Service office. These two methods for rack mounting are outlined in the following paragraphs:

2-9. COMBINING CASE. The combining case (HP 1052A) shown in Figure 2-2 is a modular unit which accepts sub-module units such as the 1/2 module, Model 4260A. The combining case can be used as a bench instrument or it can be rack mounted. A rack mounting kit (HP No. 5060-0776) is supplied with the instrument. When only half the case is used, a blank filler panel (HP No. 5060-0794) is available to enclose the unused half.

2-10. ADAPTER FRAME. The adapter frame (HP No. 5060-0797) in Figure 2-1 is a rack frame that accepts any combination of sub-module units; it can only be rack mounted. Install instruments in the adapter frame as follows:

- a. Place adapter frame on edge of bench and stack sub-module units (steps 1 and 2) in frame. Place spacer clamp between units (step 3).
- b. Insert two end spacer clamps (step 4) and push units into frame.
- c. Insert screws on either side of frame (step 5) and tighten until units are tight in frame.
- d. The complete assembly is now ready for rack mounting.

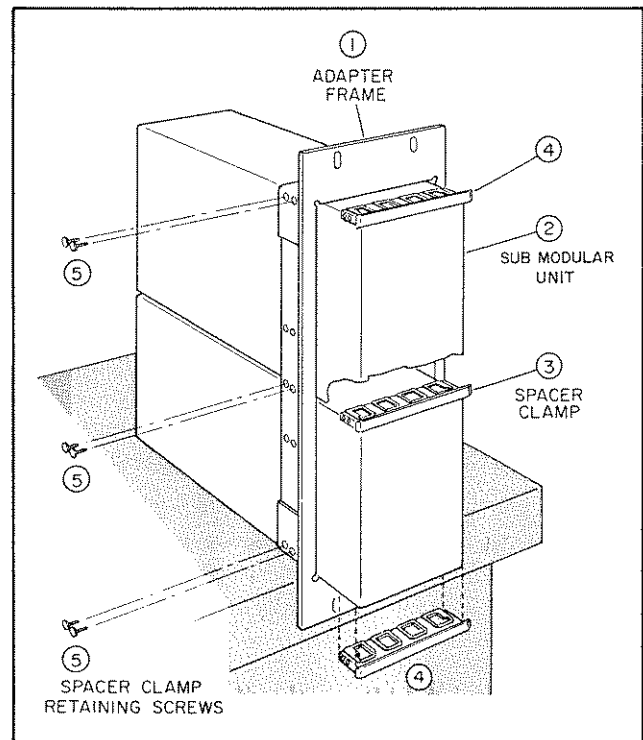

Figure 2-1. Adapter Frame

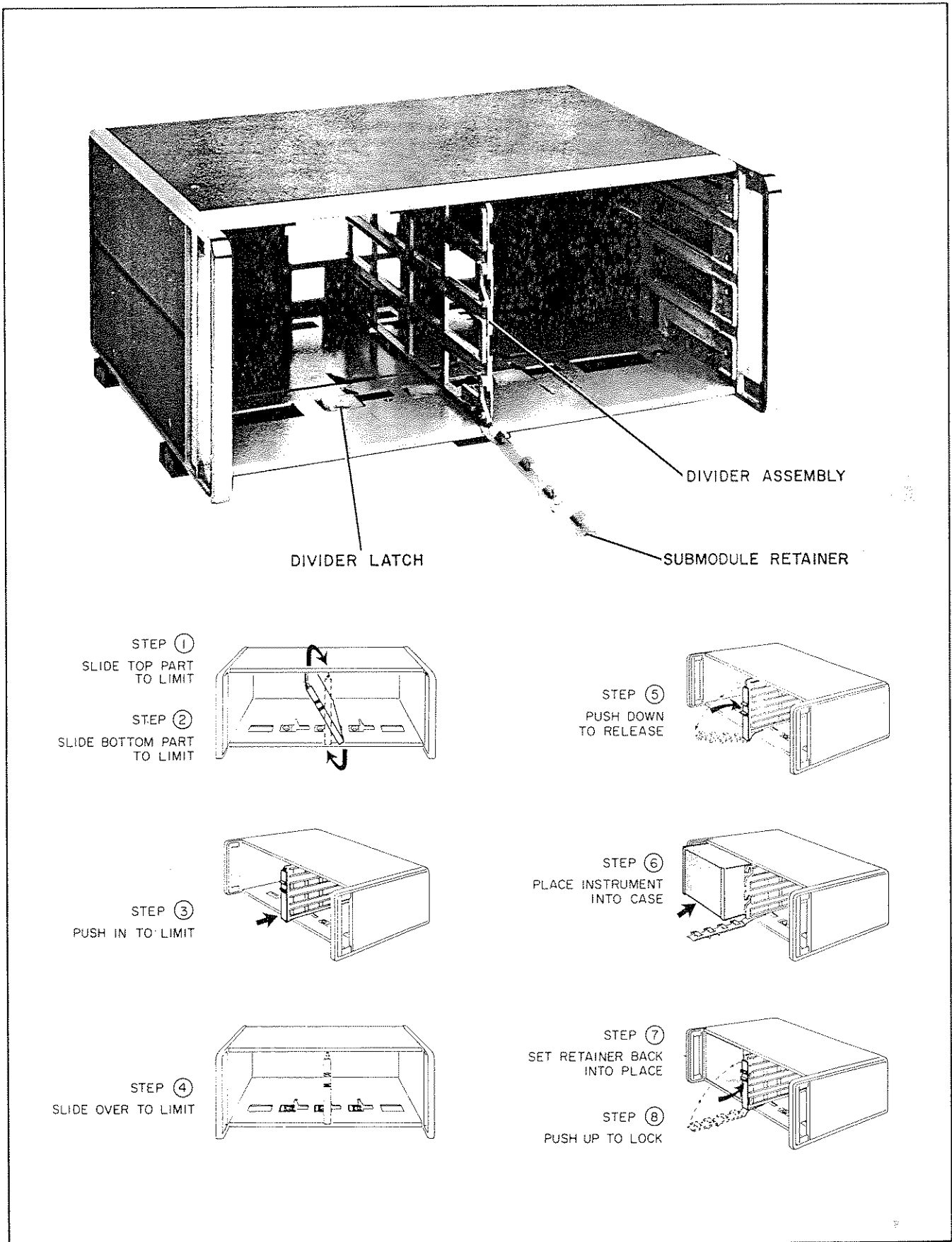

Figure 2-2. Combining Case

2-11. OPERATION FROM 115 OR 230 VOLTS.

2-12. The Model 4260A can be operated from either 115- or 230-volt ($\pm 10\%$) 50 to 60 Hz power lines. A slide switch on the rear panel permits quick conversion for operation from either voltage. Insert a narrow blade screwdriver in the switch slot and slide the switch to expose "115" marking for 115-volt operation or "230" marking for 230-volt operation. The instruments are supplied with a 0.1 ampere fuse for either 115- or 230-volt operation.

CAUTION

Do not change the 115/230 switch setting during operation.

2-13. 3-CONDUCTOR POWER CABLE.

2-14. The Model 4260A is equipped with detachable 3-wire power cable. Proceed as follows for installation:

a. Connect flat plug (3-conductor female connector) to AC line jack at rear of instrument.

b. Connect plug (2-blade male with round grounding pin) to 3-wire (grounded) power outlet. Exposed portions of instrument are grounded through the round pin on the plug for safety; when only the 2-blade outlet is available, use connector adapter (HP Stock No. 1251-0048), then connect short wire from side of adapter to ground.



10

11

12

SECTION III OPERATION

3-1. INTRODUCTION.

3-2. This section outlines operation of the Universal Bridge. An operating procedure is given for each measurement function. All front and rear controls, connectors, and indicators are briefly explained in Figure 3-1.

3-3. TURN-ON PROCEDURE.

3-4. Before applying power to the instrument, set controls as follows:

- a. Set FUNCTION control for type of measurement to be made and RANGE switch near mid-range.
- b. Set SENSITIVITY control near full counterclockwise to reduce meter sensitivity.
- c. Set CRL control to 1030.
- d. Set red VERNIER DQ knob full counterclockwise to CAL.
- e. Set rear-panel 115/230 volt switch to expose numbers which correspond to the line voltage used.
- f. Set rear-panel OSCILLATOR switch to INT 1 KC. Three rear shorting straps should be in place (see Paragraph 3-42 for special measurements).
- g. If meter pointer is not mechanically centered, center as follows:

- (1) Turn instrument off. Wait 30 seconds for all capacitors to discharge.
- (2) Remove two screws which hold top cover to rear panel and slide cover toward rear.
- (3) Locate the black zero adjust screw at top center of meter. Rotate screw clockwise until meter pointer is to left of zero and begin moving right toward zero.
- (4) Continue to rotate screw clockwise; stop when pointer is on zero. If the pointer overshoots zero, repeat steps (3) and (4).
- (5) When pointer is exactly on zero, rotate screw approximately 15 degrees counterclockwise. This is enough to free the adjustment screw from the meter suspension. If pointer moves during the step, repeat steps (4) and (5).

h. Apply power to instrument by connecting ac power cord and setting LINE switch to ON. One of the decimal point lights in the CRL counter will light to indicate power is applied to the instrument. Allow 30 seconds for the instrument to stabilize. The 4260A is now ready to use. The following paragraphs outline procedures for standard R, L, and C measurements.

3-5. USE OF THE DQ VERNIER.

3-6. The DQ VERNIER control provides fine electrical adjusting during D or Q measurements. The DQ dial setting does not change as the DQ VERNIER is changed. For any setting of the DQ VERNIER, DQ dial accuracy is maintained as outlined in Specifications. The DQ vernier is useful for large D or small Q measurements. Using the DQ vernier for a bridge null prevents false nulls caused by lack of resolution with the DQ control. DQ VERNIER ranges are:

- 0 (CAL) to 0.001 in LOW D range
- 0 (CAL) to 0.016 (of 1/D) in HIGH D range
- 0 (CAL) to 0.016 in LOW Q range
- 0 (CAL) to 0.001 (of 1/Q) in HIGH Q range

3-7. DC RESISTANCE MEASUREMENTS.

3-8. POWER CONSIDERATIONS.

3-9. Power applied to the unknown resistor will vary depending upon the unknown value, the RANGE switch position, and the CRL control setting. Maximum open circuit voltage across the UNKNOWN terminals is 40 Vdc. Short-circuit current through the UNKNOWN terminals is 25 milliamperes maximum. Voltage across the unknown resistor can be measured with a high input impedance Voltmeter such as the HP 410C, 412A, or 413A (see Paragraph 3-15). Current through the unknown resistor can be measured with a clip-on milliammeter such as the HP 428B (see Paragraph 3-15).

3-10. MEASUREMENTS.

3-11. Resistance values between 100 ohms and 10 kilohms can be measured quickly with 1% accuracy by using only front-panel controls. For measurements of values between 10 milliohms and 100 ohms or between 10 kilohms and 10 megohms, an external null meter such as the HP 413A is desirable for better sensitivity during the measurements. These two types of measurements are outlined as separate procedures in the following paragraphs.

3-12. 100 OHM to 10 K OHM MEASUREMENTS.

- a. Perform the turn-on procedure outlined in Paragraph 3-3.
- b. Set FUNCTION switch to R position.
- c. Connect the resistor to be measured to the UNKNOWN terminals.
- d. Set RANGE switch for meter indication near center and increase meter sensitivity by rotating SENSITIVITY control clockwise. If meter indication is right of center, turn CRL control ccw. If left, turn CRL control cw. Adjust CRL control for meter center indication while increasing SENSITIVITY control to maximum sensitivity (full cw).

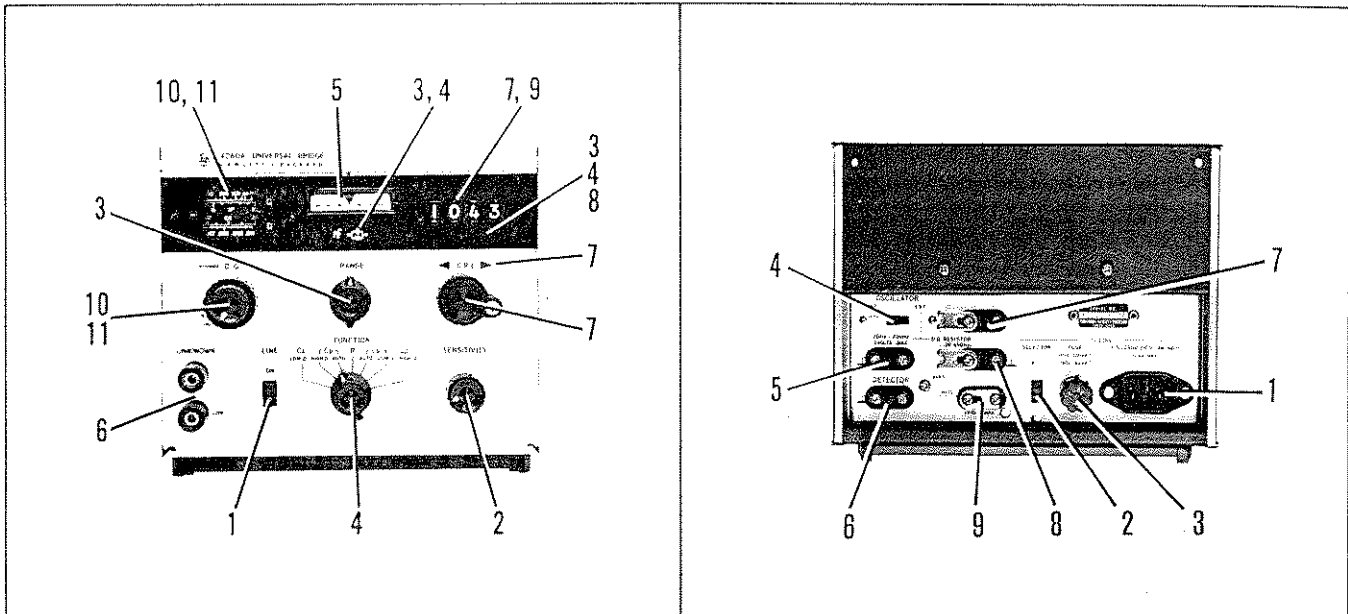

FRONT PANEL

1. LINE Switch: applies ac line voltage to instrument.
2. SENSITIVITY: controls meter sensitivity; cw for max.
3. RANGE switch: selects measurement range. Mechanically controls equivalent circuit and units displayed in window below meter and also pointer for DQ dial.
4. FUNCTION switch: selects type of measurement. Mechanically controls units value displayed in window below meter. Changes decimal point placement in numerical display.
5. Null Meter: indicates null at center scale. For R measurements, meter deflects either left or right. For C or L measurements, meter deflects right only until nulled.
6. UNKNOWN terminals: connect component to be measured between these two binding posts. Connect directly or use very short leads. See "WARNING" in paragraph 3-23d.
7. CRL control: adjusts bridge balance for meter null during measurements. Mechanically connected to numerical counter which indicates R, L, or C measured value. Direction lights just above control indicate rotation direction for null on meter (for Cp AUTO or Ls AUTO functions only).
8. Decimal Point Lights: one of three lights (selected by FUNCTION and RANGE switch positions) indicates correct decimal point. Light on indicates ac line voltage is applied to the instrument.
9. Numerical Counter: displays value of R, L, or C. Mechanically driven by CRL control. Range is from 0000 to 1030.
10. DQ Control: outer black knob rotates DQ dial for D or Q measurements. Red center knob is a vernier; does not rotate dial. DQ scale is calibrated with vernier full counterclockwise.

11. DQ Dial: indicates Dissipation Factor (D) or Quality Factor (Q). Mechanically rotated by DQ control. Dial scales are: LOW D: .001 to .12; HIGH D, .05 to 50, LOW Q: .02 to 20; HIGH Q: 8 to 1000.

REAR PANEL

1. AC LINE Connector: connects to flat plug on power cable.
2. LINE Voltage Switch: permits operation from either 115 Vac or 230 Vac.
3. LINE fuse: 0.1 ampere provides overload protection.
4. OSCILLATOR INT-EXT switch: selects internal oscillator or external oscillator and controls error signal amplifier frequency response. For INT setting, error signal amplifier is tuned to 1 kHz; for EXT, amplifier response is flat between 20 Hz and 20 kHz.
5. External Oscillator Terminals: connect external oscillator to these terminals.
6. DETECTOR Output Terminals: error signal amplifier output supplied to external tuned amplifier or oscilloscope.
7. DQ RESISTOR Cs Lp Terminals: connect variable resistor for special low frequency D (Cs function) or Q (Lp function) measurements. Terminals normally connected together with shorting strap.
8. DQ RESISTOR Cp Ls / BIAS CAPACITOR Terminals: Connect variable resistor for special low frequency D (Cp function) or Q (Ls function) measurements. For C or L measurements with dc bias, connect a capacitor. Terminals normally connected together with shorting strap.
9. BIAS BATTERY Terminals: connect battery (6 Vdc max) for C or L measurements with dc bias. Terminals normally shorted together with shorting strap.

Figure 3-1. Front and Rear Panel Controls, Indicators and Connectors

e. Read measured resistance value on CRL counter. (Observe decimal point location and units displayed in window below meter.)

Note

For maximum resolution, final CRL counter display should be greater than 0100.

3-13. MILLIOHMS AND MEGOHMS MEASUREMENTS.
For measurements between 10 milliohms and 100 ohms or between 10 kilohms and 10 megohms, a sensitive dc null voltmeter such as the HP 413A should be used. Refer to Paragraph 3-15 for voltage and current measurements for the unknown R. Connect the null voltmeter and make resistance measurements as follows:

a. Remove the shorting strap on the voltmeter rear panel ground terminals to avoid ground loops.

b. Perform the turn-on procedure outlined in Paragraph 3-3.

c. Connect the voltmeter input ground or low terminal to the rear-panel detector ground terminal on the Universal Bridge. Connect UNKNOWN LOW terminal to the other Voltmeter input terminal.

d. Set FUNCTION switch to R.

e. Connect the resistor to be measured to the UNKNOWN terminals.

f. Set RANGE switch for meter indication near the center and increase meter sensitivity by rotating SENSITIVITY control clockwise. If meter indication is right of center, turn CRL control ccw. If left, turn CRL control cw. Adjust CRL control for meter center indication while increasing SENSITIVITY control to maximum sensitivity (full cw).

g. Read measured resistance value on CRL counter. (Observe decimal point location and units displayed in window below meter.)

CAUTION FOR LOW RESISTANCE MEASUREMENTS

For best connection to the bridge, leads should be inserted into the binding posts, and the binding posts should be screwed tightly to reduce contact resistance. Short heavy leads can be used. Lead resistance should be measured with the free ends connected together. Subtract the lead resistance from the bridge reading.

3-14. The fastest procedure for R measurements is as follows:

a. Set FUNCTION switch to R position.

b. Connect the resistor to the UNKNOWN terminals.

c. Turn CRL control cw to 1030.

d. Increase SENSITIVITY for deflection (right or left) on the null meter.

e. Rotate the RANGE switch until the meter pointer passes the null. If meter deflection is right, perform step f. If meter deflection is left, turn RANGE switch one step cw. Adjust SENSITIVITY control for right deflection.

f. Turn CRL control ccw to obtain a null on the meter; set SENSITIVITY control full cw, adjust for the null with CRL control.

g. Read the final resistance on CRL counter along with the units display.

3-15. VOLTAGE AND CURRENT FOR UNKNOWN R.
When voltage and current values for the unknown are to be measured, a dc voltmeter such as the HP 413A should be used with a current meter such as the HP 428B clip-on milliammeter. Make voltage and current measurements as follows:

a. Make the resistance measurements as outlined in Paragraph 3-12 or 3-13 and leave the Model 4260A set up for the null.

b. Remove the shorting strap on the voltmeter rear-panel ground terminals to avoid ground loops.

c. Connect the voltmeter input ground or low terminal to the rear-panel detector ground terminal on the Universal Bridge. Connect the UNKNOWN high terminal to the other voltmeter input terminal.

d. Read voltage across the unknown R on the voltmeter.

e. For current through the unknown R, clip the milliammeter probe to one of the unknown leads and read unknown current.

3-16. CAPACITANCE MEASUREMENTS.

3-17. INTRODUCTION.

3-18. Capacitance measurements are normally made at a frequency of 1 kHz from the internal oscillator. For C measurements at frequencies between 20 Hz and 20 kHz, an external oscillator can be connected, as outlined in Paragraph 3-42, Special Measurements. Direction lights indicate the correct rotation direction for Cp AUTO measurements. The measured C value is displayed on the CRL counter with correct decimal point location, units and equivalent circuit also displayed. Dissipation factor (D) can be measured after the bridge is balanced for the capacitance measurement. The measured D value is displayed on the DQ dial.

3-19. RESIDUAL CAPACITANCE.

3-20. The residual capacitance of the UNKNOWN terminals can be measured with nothing connected to these terminals. Its value is typically 2 pf or less. When small capacitance measurements are made, this residual capacitance should be subtracted from the measured value. If external leads are used to connect the unknown, the residual capacitance measurement should include the lead capacitance. Errors caused by residual and lead capacitances are listed in Table 3-1.

Table 3-1. Correction Terms for Residual Lead Errors
 (Add to Measured Value as Indicated)

Measured Quantity	Series Resistance R_o	Series Inductance L_o	Parallel Capacitance C_o
C_s	No error	$-4\pi^2 f^2 L_o C_x^2$	$-C_o (1 - D_x^2)$
D of C_s	$-2\pi f R_o C_x$	$-4\pi^2 f^2 L_o C_x D_x$	$+ D_x (1 + D_x^2) C_o / C_x$
C_p	$+4\pi f R_o C_x^2 D_x$	$-4\pi^2 f^2 L_o C_x^2 (1 - D_x^2)$	$-C_o$
D of C_p	$-2\pi f R_o C_x (1 + D_x^2)$	$-4\pi^2 f^2 L_o C_x D_x (1 + D_x^2)$	$+ D_x C_o / C_x$
R	$-R_o$	No error	No error
L_s	No error	$-L_o$	$-4\pi^2 f^2 C_o L_x^2 (1 - \frac{1}{Q_x^2})$
Q of L_s	$+ Q_x^2 \frac{R_o}{2\pi f L_x}$	$-\frac{L_o}{L_x} Q_x$	$+4\pi^2 f^2 C_o L_x (Q_x + \frac{1}{Q_x})$
L_p	$-\frac{R_o}{\pi f Q_x}$	$-L_o (1 - \frac{1}{Q_x^2})$	$-4\pi^2 f^2 C_o L_x^2$
Q of L_p	$+\frac{R_o}{2\pi f L_x} (1 + Q_x^2)$	$-\frac{L_o}{L_x} (Q_x + \frac{1}{Q_x})$	$+4\pi^2 f^2 C_o L_x Q_x$
where f is frequency C_x is unknown capacitance D_x is unknown D L_x is unknown inductance Q_x is unknown Q			

3-21. Cs AND Cp MEASUREMENT DIFFERENCES.

3-22. The measured value of capacitance depends on whether a series or parallel equivalent circuit is used for the measurement. The relationship between a series capacitance (C_s) circuit and a parallel capacitance (C_p) circuit is as follows: $C_s = (1 + D^2) C_p$, where D is the measured D value. The difference between C_s and C_p is large when D is greater than 0.1 but C_s is within 1% of C_p if D is 0.1 or less.

3-23. MEASUREMENT PROCEDURE.

- Perform the turn-on procedure outlined in Paragraph 3-3.
- Check to insure that the 3 DQ RESISTOR and BIAS terminal pairs on the rear panel are shorted with their respective shorting straps.
- Rotate the SENSITIVITY control full ccw.
- Set FUNCTION switch to Cp AUTO position. "WARNING" - Discharge capacitor to be tested before connecting to UNKNOWN terminals.
- Connect the capacitor to be measured to the UNKNOWN terminals. "WARNING" - Discharge capacitor to be tested before connecting to UNKNOWN terminals.

f. If the right direction indicator is lit, rotate CRL control clockwise. If the left direction indicator is lit, rotate CRL control counterclockwise. Rotate SENSITIVITY control clockwise to give near full scale meter deflection.

g. If the CRL control is fully cw and the right direction indicator remains lit, turn RANGE switch ccw until left direction indicator lights. Adjust CRL control for meter null and rotate SENSITIVITY control cw as null is approached.

h. When null (bridge balance) is achieved below 0100 on the CRL indicator, set RANGE switch to the next position cw and rotate CRL control for null indication. (This is possible for all measurements above 100 pf.) Capacitance is indicated on the CRL counter.

i. To measure D for the unknown capacitor, set FUNCTION switch to Cp HIGH D position.

j. Adjust DQ control for minimum meter indication. (The CRL control can be adjusted slightly for best null.)

k. When a null indication is impossible in the Cp HIGH D position, set FUNCTION switch to Cs LOW D.

Adjust DQ control for minimum meter indication. The D of the unknown capacitor is read from the D scale indicated by the red pointer in the DQ window.

3-24. The fastest procedure for C measurements is as follows:

- a. Set FUNCTION switch to Cp AUTO position.
- b. Connect capacitor to unknown terminals.
- c. Turn the CRL control cw to 1030.
- d. Rotate RANGE switch until a crossover point of the indicator lights is obtained. (Left indicator lights instead of right one and vice versa.) If you cannot obtain a crossover, see step e note.
- e. If left indicator lights, adjust SENSITIVITY control for a right deflection of the null meter pointer. If the right indicator lights, turn RANGE switch one step ccw and adjust SENSITIVITY control for a right deflection of the null meter pointer. Note: if the right indicator stays lit regardless of the RANGE switch position, the unknown value of the capacitor must be beyond the highest range of the bridge ($> 1000 \mu\text{f}$). If the left indicator stays lit regardless of the RANGE switch position, the unknown value of the capacitor must be below 1000 pF.
- f. Rotate the CRL control ccw until a crossover of the indicator lights is obtained.
- g. Set SENSITIVITY full cw and adjust for null with CRL control.
- h. Read final capacitor value on the CRL counter and units display.

3-25. VOLTAGE ACROSS UNKNOWN C.

3-26. When voltage across the unknown C is to be measured, a vacuum tube voltmeter such as an HP 400D, 400H, or 400L should be used. The procedure is as follows:

- a. Make the capacitance measurement as outlined in Paragraph 3-23, and leave the instrument set up at null.
- b. Isolate the Voltmeter from power line ground by using a two-prong power cord adapter and leaving the adapter pigtail lead disconnected from ground.
- c. Connect the Voltmeter input ground terminal to the 4260A rear panel detector ground terminal.
- d. Connect the other voltmeter input terminal to the 4260A UNKNOWN terminal (not the LOW terminal). Read the voltage across the unknown C on the voltmeter.

3-27. INFLUENCE OF D IN Cp AUTO MEASUREMENT.

3-28. The accuracy that is specified for Cp AUTO measurement is obtained when D is less than 1. When D is greater than 1, accuracy of Cp AUTO measure-

ment is reduced due to the reactance of the variable resistance circuit of the AUTO null. Typical data is shown in Figure 3-2.

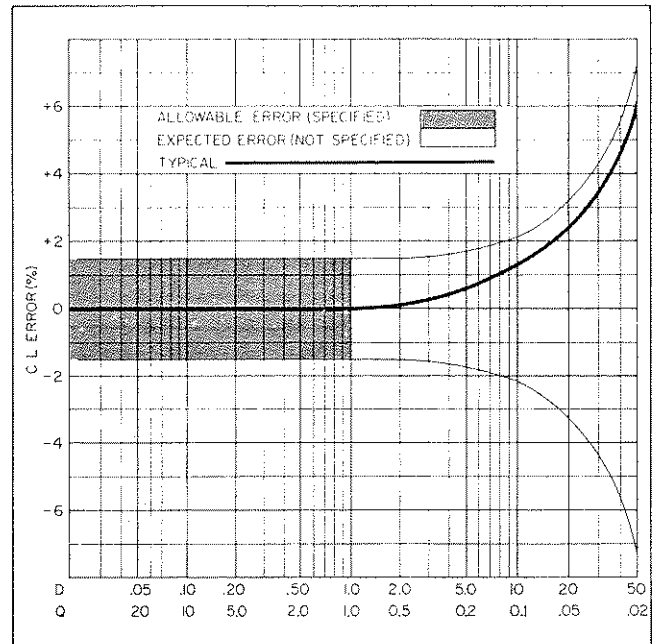

Figure 3-2. Capacitance and Inductance Errors in AUTO vs D & Q

3-29. INDUCTANCE MEASUREMENTS.

3-30. INTRODUCTION.

3-31. Inductance measurements are normally made at frequency of 1 kHz from the internal oscillator. For L measurements at frequencies between 20 Hz and 20 kHz, an external oscillator can be connected, as outlined in Paragraph 3-42, Special Measurements. Direction lights indicate the correct rotation direction for Ls AUTO measurements. The measured L value is displayed on the CRL counter with correct decimal point location, units, and equivalent circuit also displayed. Quality factor (Q) can be measured after the bridge is balanced for the inductance measurement. The measured Q value is displayed on the DQ dial.

3-32. RESIDUAL INDUCTANCE.

3-33. Residual inductance of the UNKNOWN terminals can be measured with heavy short wire connected to these terminals. Its value is typically $1 \mu\text{h}$ or less. When small inductance measurements are made, this residual inductance should be subtracted from the measured value. If external leads are used to connect the unknown, the residual inductance measurement should include the lead inductance. Errors caused by residual and lead inductances are listed in Table 3-1.

3-34. Ls AND Lp MEASUREMENT DIFFERENCES.

3-35. The measured value of inductance depends on whether a series or parallel equivalent circuit is used for the measurement. The relationship between a series inductance (Ls) circuit and a parallel inductance (Lp) circuit is as follows:

$$L_s = \frac{1}{1 + \frac{1}{Q^2}} L_p,$$

where Q is the measured Q value. The difference between L_s and L_p is large when Q is smaller than 10, but L_s is within 1% of L_p if Q is 10 or greater.

3-36. MEASUREMENT PROCEDURE.

a. Perform the turn-on procedure outlined in Paragraph 3-3.

b. Check to insure that the 3 DQ RESISTOR and BIAS terminal pairs on the rear panel are shorted with their respective shorting straps.

c. Rotate the SENSITIVITY control full ccw.

d. Set FUNCTION switch to L_s AUTO position.

e. Connect the inductor to be measured to the UNKNOWN terminals.

f. If the right direction indicator is lit, rotate CRL control clockwise. If the left direction indicator is lit, rotate CRL control counterclockwise. Rotate SENSITIVITY control clockwise to give near full scale meter deflection.

g. If the CRL control is fully cw and the right direction indicator remains lit, turn RANGE switch cw until left direction indicator lights. Adjust CRL control for meter null and rotate SENSITIVITY control cw as null is approached.

h. When null (bridge balance) is achieved below 0100 on the CRL counter, set RANGE switch to next position ccw and rotate CRL control for null indication. (This is possible for all measurements above 100 μ H.) Inductance value is indicated on the CRL counter.

i. To measure Q for the unknown inductor, set the FUNCTION switch to L_s LOW Q position.

j. Adjust DQ control for minimum meter indication. (The CRL control can be adjusted slightly for best null.)

k. When a null indication is impossible in the L_s LOW Q position, set FUNCTION switch to L_p HIGH Q. Adjust DQ control for minimum meter indication. The Q of the unknown inductor is read from the Q scale indicated by the red pointer in the DQ window.

3-37. The fastest procedure for L measurements is as follows:

a. Set FUNCTION switch to L_s AUTO position.

b. Connect inductor to unknown terminals.

c. Turn CRL control cw to 1030.

d. Rotate RANGE switch until a crossover point of the indicator lights is obtained. (Left indicator lights instead of right one and vice versa.) If you cannot obtain a crossover, see step e note.

e. If the left indicator lights, adjust SENSITIVITY control for right deflection of the null meter pointer. If the right indicator lights, turn RANGE switch one step cw and adjust SENSITIVITY control for right deflection of the null meter pointer. Note: if the right indicator stays lit regardless of the RANGE position, the unknown value of the inductor must be beyond the highest range of the bridge (> 1000 H). If the left indicator stays lit regardless of the RANGE position, the unknown value of the inductor must be below 1000 microhenries.

f. Rotate CRL control ccw until a crossover of the indicator lights is obtained.

g. Set SENSITIVITY full cw and adjust for null with the CRL control.

h. Read final inductor value on the CRL counter and units display.

3-38. VOLTAGE ACROSS UNKNOWN L.

3-39. When voltage across the unknown L is to be measured, a vacuum tube voltmeter such as an HP 400D, 400H, or 400L should be used along with a capacitive voltage divider (HP 11041A). The procedure is as follows:

a. Make the inductance measurement as outlined in Paragraph 3-36, and leave the instrument set up at null.

b. Isolate the Voltmeter from power line ground by using a two-prong power cord adapter and leaving the adapter pigtail lead disconnected from ground.

c. Connect the Voltmeter divider ground lead to the 4260A rear panel detector ground terminal.

d. Connect the Voltmeter divider probe to the UNKNOWN terminal (not the LOW terminal). Read the voltage across the unknown L on the Voltmeter.

3-40. INFLUENCE OF Q IN L_s AUTO MEASUREMENT.

3-41. The accuracy specified for L_s AUTO measurement is obtained when Q is more than 1. When Q is smaller than 1, accuracy of the L_s AUTO measurement is reduced due to the reactance of the variable resistance circuit of the AUTO NULL. Typical data is shown in Figure 3-2.

3-42. SPECIAL MEASUREMENTS.

3-43. 20 Hz TO 20 kHz MEASUREMENTS.

3-44. Since the 4260A internal oscillator frequency is fixed at 1 kHz, an external generator must be connected for measurements at frequencies between 20 Hz and 20 kHz. For such measurements, an audio oscillator with 600 ohms output impedance (Hp 208A, 204B, or 200CD) and a voltmeter (HP 403B or 400D, 400H, 400L) are recommended.

3-45. If the presence of a non-linear unknown causes appreciable distortion in the 4260A detector, the best null indication may not give the correct value for the

measured unknown. Also, if electromagnetic or static induction from the ac line or other source affects the unknown, a satisfactory null indication will be difficult. In these cases, a tuned null detector or selective amplifier with 90 dB gain and input impedance above 10K ohms is recommended.

Note

The electronic auto null circuit and direction indicator lights do not operate for measurements with an external oscillator.

3-46. OPERATION WITH EXTERNAL GENERATOR.

CAUTION

DO NOT APPLY MORE THAN 2 VOLTS RMS AT THE EXT. OSCILLATOR TERMINALS.

3-47. For impedance measurements at frequencies other than 1 kHz (between 20 Hz and 20 kHz), connect the external oscillator and associated equipment as shown in Figure 3-3 and proceed.

a. Check to insure that the DQ RESISTOR Cs Lp and Cp Ls terminals and BIAS terminals on the instrument rear panel are shorted by their shorting straps.

b. Set external oscillator output voltage to minimum and connect to EXT. OSCILLATOR terminals (see Figure 3-3).

c. For the most accurate and sensitive measurements, a tuned null detector such as the HP 302A is recommended. However, an oscilloscope with 100 microvolt/cm such as the HP 140A with 1400A plug-in can be used. Connect the 4260A UNKNOWN LOW terminal to the null detector high input terminal. Connect the detector low or ground terminal to the 4260A rear-panel detector ground terminal.

Note

Bridge null can be obtained using a tuned null detector with less than 90 dB gain connected to the DETECTOR terminals. (The DETECTOR terminals are connected to the output of the internal pre-amplifier.) For most accurate and sensitive measurements, the method shown in Figure 3-3 is recommended.

d. Set the 4260A INT-EXT OSCILLATOR switch to EXT.

e. Set the FUNCTION switch to Cs LOW D or Cp HIGH D for capacitance measurements, or to Ls LOW Q or Lp HIGH Q for inductance measurements.

f. Connect the unknown component to the UNKNOWN terminals.

g. Adjust the SENSITIVITY control for near full scale deflection and set RANGE switch for minimum on meter.

h. Adjust CRL and DQ controls for minimum meter indication. SENSITIVITY control can be adjusted cw as bridge balance is approached.

i. Read capacitance or inductance of the unknown on the CRL counter. Correct decimal point, units, and equivalent circuit are also displayed. The D or Q of the unknown is computed as follows:

For LOW D (D of series C): $D_f = \frac{D_r(f)}{1 \text{ kHz}}$ where D_f is

the D value at applied frequency f (kHz), D_r is the D reading on the D scale.

For HIGH D (D of parallel C): $D_f = D_r \left(\frac{1 \text{ kHz}}{f} \right)$.

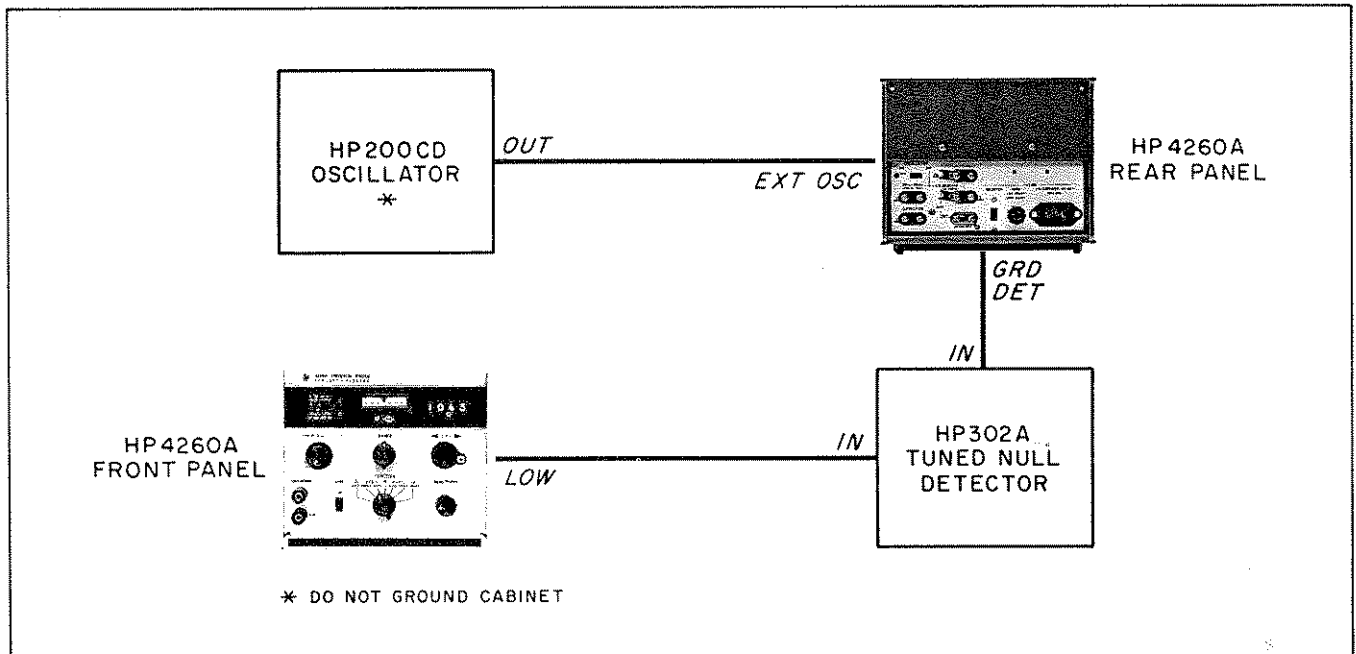

Figure 3-3. Operation with External Generator

For LOW Q (Q of series L): $Q_f = Q_r \frac{f}{1 \text{ kHz}}$
 where Q_f is the Q value at applied frequency f (kHz)
 and Q_r is the Q reading on the Q scale.

For HIGH Q (Q of parallel L): $Q_f = Q_r \frac{1 \text{ kHz}}{f}$

3-48. INFLUENCE OF RESIDUAL AND LEAD IMPEDANCES.

3-49. At frequencies above 1 kHz, errors resulting from residual bridge impedances and lead impedances become significant. Table 3-1 lists the correction terms for these errors.

3-50. D AND Q MEASUREMENTS.

3-51. GENERAL. Measured D or Q values are a function of the frequency applied during measurement. Figure 3-4 illustrates the possible values of D or Q for minimum error at various frequencies. D or Q values which fall in the overlap area of Figure 3-4 can be measured with the FUNCTION switch set for any D or Q measurement except AUTO. However, below 650 Hz there is a group of D or Q values (shaded area of Figure 3-4) which can be measured by adding an external DQ resistor. This DQ resistor addition is outlined in the following paragraph.

3-52. EXTENDING THE D AND Q RANGES. An external resistor added at the instrument rear-panel DQ RESISTOR terminals will extend the D and Q ranges. To avoid error, Cp HIGH D and Ls LOW Q should not be extended below a value of 0.1 at the frequency of measurement. The DQ resistor should be added as follows:

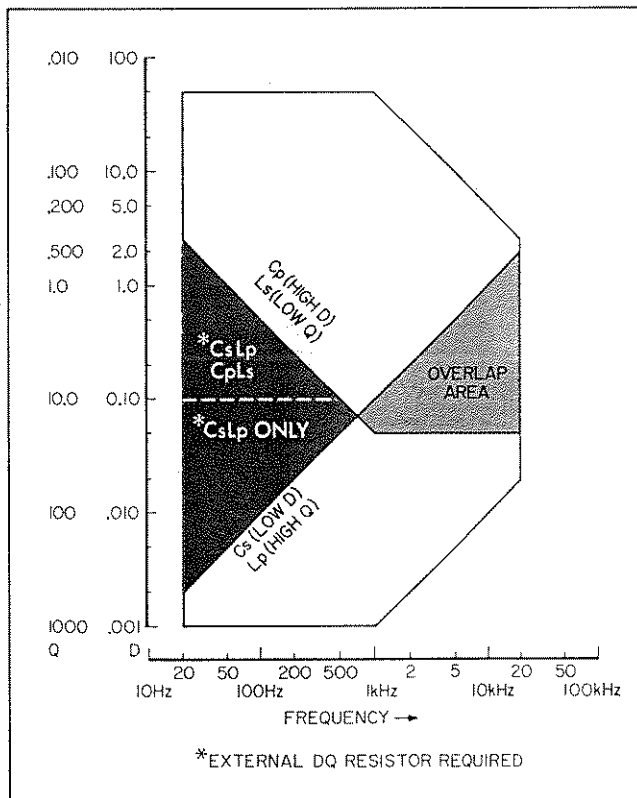

Figure 3-4. DQ Range vs Frequency

a. For Cs LOW D or Lp HIGH Q measurements, remove the shorting strap from the rear-panel DQ RESISTOR Cs Lp terminals.

b. The external resistor should be selected as follows:

- 1) maximum current: 6 milliamperes, resistance range: 0 to 300K ohms.
- 2) use a metal film or carbon film resistor.

Note

The resistance of the external resistor used can be measured with the 4260A after the D or Q measurement is completed.

c. Connect the external resistor to the DQ resistor terminals from which the shorting strap was removed in step a.

d. With the external DQ resistor and oscillator connected, balance the bridge with the RANGE switch, CRL, and DQ controls. Read the value of the unknown from the CRL counter and decimal point, units, and equivalent circuit as displayed.

3-53. The D or Q or the unknown is given as follows: for LOW D (D of Cs), $D_f = (1.256R + D_r) f$ where D_f is the D value at applied frequency f (kHz); D_r is the D reading on the D scale; and R is the external resistor value in K ohms. For HIGH D (D of Cp),

$$D_f = \frac{1}{(1.256R + \frac{1}{D_r}) f}$$

For LOW Q (Q of Ls), $Q_f = (1.256R + Q_r) f$; where Q_f is the Q value at applied frequency f (kHz); Q_r is the Q reading on the Q scale; and R is the external resistor value in K ohms. For HIGH Q (Q of Lp),

$$Q_f = \frac{1}{(1.256R + \frac{1}{Q_r}) f}$$

3-54. C MEASUREMENTS WITH DC BIAS.

3-55. GENERAL. A dc bias voltage (6 vdc maximum) can be applied to capacitors such as electrolytic types during the C measurement. Figure 3-5 schematically illustrates the dc bias application. Operating procedure for dc-biased measurements is described below and pictorially shown in Figure 3-5. The following equipment will be required:

1. 6 Vdc battery or dry cell.
2. electrolytic capacitor (aluminum or tantalum) designated C_V) 6 Vdcw, more than 100 μF at 1 kHz or more than $(100 \text{ kHz}/f) \mu F$.
3. dc voltmeter, VTVM not required.
4. electrolytic capacitor (aluminum or tantalum) designated C_L) 6 Vdcw, more than $(20D_x^2) \mu F$ for less than 1% error measurements. D_x is the D value of the unknown.

With the FUNCTION switch set to Cp HIGH D, the capacitance of C_L required depends upon the unknown D and desired accuracy. The error introduced by C_L is:

$$\text{measured } C = C_X \left(1 - \frac{C_t}{C_L} D_X^2 \right) \text{ and}$$

$$\text{measured } D = D_X \left(1 + \frac{C_t}{C_L} D_X^2 \right),$$

where $C_t = 0.2 \mu\text{F}$ and C_X or D_X is the correct C or D value of the unknown.

3-56. PROCEDURE.

a. Connect the measurement setup as shown in Figure 3-5. All instrument cabinets except 4260A must be isolated from power line ground.

b. Connect the unknown C to the UNKNOWN terminals.

CAUTION

The LOW UNKNOWN terminal is at dc positive potential. DO NOT APPLY A DC BIAS VOLTAGE GREATER THAN 6 VDC OR A DC BIAS CURRENT GREATER THAN 10 MILLIAMPERES.

c. Set FUNCTION switch to Cp AUTO position for measurements with the internal 1 kHz generator. Adjust RANGE switch and CRL control for bridge balance (meter null). Read the measured C value on the CRL counter.

3-57. L MEASUREMENTS WITH DC BIAS.

3-58. GENERAL. A dc bias voltage (6 Vdc maximum) can be applied to an unknown inductor during the L

measurement. Figure 3-6 schematically illustrates the dc bias application. Operating procedure for dc-biased measurements is described below and pictorially shown in Figure 3-6. The following equipment will be required:

1. 6 Vdc battery or dry cell.
2. electrolytic capacitor (designated C_Y), aluminum or tantalum, 6 Vdcw, more than $100 \mu\text{F}$ at 1 kHz or more than $(100 \text{ kHz/f}) \mu\text{F}$.
3. dc milliammeter, VTVM not recommended, or clip-on milliammeter HP 428B.
4. electrolytic capacitor (designated C_L), aluminum or tantalum, 6 vdcw, more than $(20/Q_X^2) \mu\text{F}$ for less than 1% error measurements. Q_X is the Q of the unknown L.

With the FUNCTION switch set to Lp HIGH Q, the capacitance of C_L depends upon the unknown Q and desired accuracy. The error introduced by C_L is:

$$\text{measured } L = L_X \left(1 - \frac{C_t}{C_L Q_X^2} \right)$$

$$\text{measured } Q = Q_X \left(1 - \frac{C_t}{C_L Q_X^2} \right), \text{ where } L_X \text{ or } Q_X \text{ is}$$

the correct L or Q value of the unknown.

3-59. PROCEDURE.

a. Connect the measurement setup as shown in Figure 3-6. Ground only the 4260A cabinet to power line ground.

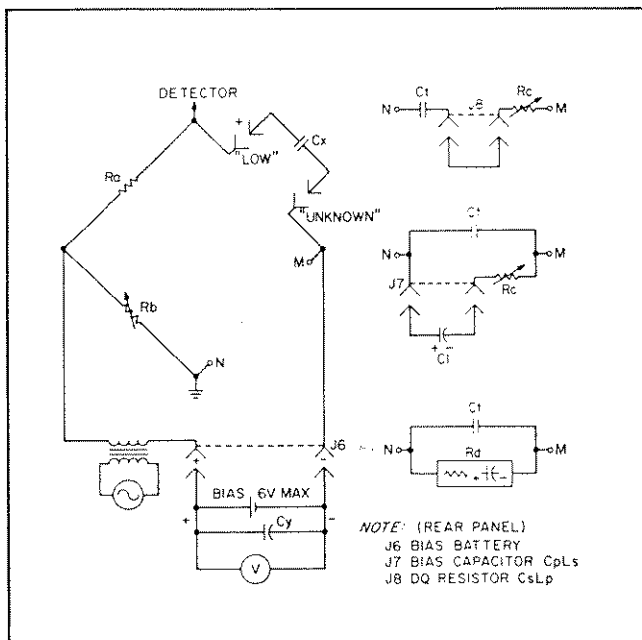

Figure 3-5. Dc Biased Capacitance Measurement

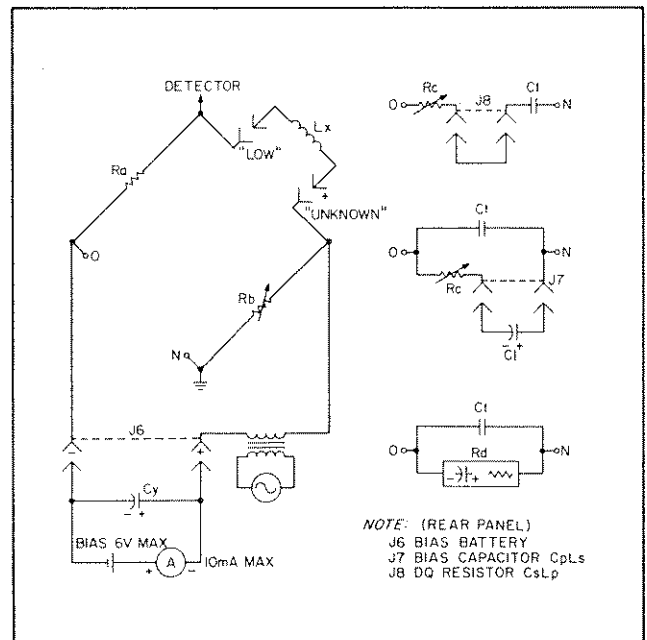

Figure 3-6. Dc Biased Inductance Measurement

b. Connect the unknown L to the UNKNOWN terminals.

CAUTION

DO NOT APPLY A DC BIAS VOLTAGE GREATER THAN 6 VDC OR A DC BIAS CURRENT GREATER THAN 10 MA.

c. Set FUNCTION switch to Ls AUTO position for measurements with the internal 1 kHz generator. Adjust RANGE switch and CRL control for bridge balance (meter null). Read the measured L value on the CRL counter.

3-60. RESISTANCE MEASUREMENT AT 1 KHZ.

3-61. To make AC resistance measurement at 1 kHz refer to Figure 3-1. and perform the following steps:

a. Remove shorting strap across DQ RESISTOR (CsLp) terminals on rear panel.

b. Connect accurate 500 ohm metal film resistor ($\pm 1\%$ or less) between right CsLp terminal and CpLs terminal immediately below. DO NOT REMOVE STRAP ON CpLs TERMINAL.

c. Set DQ knobs full counter clockwise.

d. Set FUNCTION switch to Lp HIGH Q.

e. Make measurement using RANGE switch and CRL dial.

f. Multiply inductance reading in Henries by 10,000 to convert to ohms. For example, 1 millihenry is 10 ohms.

SECTION IV

THEORY OF OPERATION

4-1. INTRODUCTION.

4-2. This section includes circuit operation details for the Universal Bridge. A general description of operation is given first, with details of the various circuits following. Each assembly in the instrument is discussed in the order of its assembly designation (A100, A200, etc.) as listed in Table 4-1.

Table 4-1. Assembly Designations

A100	Range and Function Switch	04260-7055
A200	Power Supply and 1 kHz Oscillator	04260-7022
A300	Reference Voltage	04260-7023
A400	Detector	04260-7724
A600	Decimal Point and Direction Indicator	04260-7026

4-3. DESCRIPTION.

4-4. GENERAL.

4-5. For capacitance and inductance measurements with the FUNCTION switch set to Cp AUTO or Ls AUTO, a 1 kHz signal drives the bridge and balance is achieved by selecting the proper range and adjusting only the CRL control. This is possible because a voltage-controlled resistor is substituted for one resistor in the bridge circuit. Thus, simultaneous adjustment of more than one control is eliminated.

4-6. BLOCK DIAGRAM.

4-7. Figure 8-2 illustrates the bridge and auto null circuits. The auto null circuits are used when the FUNCTION switch is set to Cp AUTO or Ls AUTO position. As seen in Figure 8-2, the phase detector receives two signals: 1) an error voltage from the detector amplifier which is proportional to bridge unbalance, and 2) a reference voltage derived from the 1 kHz signal source. The phase detector output voltage is therefore proportional to bridge unbalance. This proportional voltage is applied through a dc amplifier to the voltage-controlled resistor circuit. This controlled value is the resistance of the one arm of the bridge. As the CRL control is rotated to achieve bridge balance, the voltage-controlled resistor value electronically follows the CRL control. Thus, when bridge balance is achieved, no error voltage is present and the null meter indicates zero.

4-8. In generating the reference signal input to the phase detector, two voltages are applied to the reference phase comparator. The comparator voltage output has a phase relationship, θ , with respect to the driving signal. The phase multiplier translates this relationship to 2θ , since 2θ is the most effec-

tive angle for maximum sensitivity in the circuit. This 2θ information is applied to the reference voltage generator and a 1 kHz square wave results which is displaced in phase by 2θ from the driving voltage. The generated 2θ reference signal is then applied to the phase detector for comparison with the bridge error voltage.

4-9. BASIC BRIDGE FOR RESISTANCE MEASUREMENTS.

4-10. Figure 4-1A shows the basic bridge circuit used to measure resistance. A four-arm bridge circuit is formed by resistors Ra, Rx, Rs, and Rb. Rx is the fixed unknown R to be measured; Ra is determined by the value of Rx; Rs is a fixed value; and Rb is variable to adjust for bridge balance. In actual use, the Model 4260A bridge circuit is adjusted for a null indication on the meter with the CRL control and the unknown resistance is read directly from the display with correct units and decimal point placement.

4-11. BASIC CIRCUITS FOR CAPACITANCE MEASUREMENTS.

4-12. Figure 4-1B illustrates the basic bridge circuit for parallel capacitance (Cp HIGH D) measurements at 1 kHz. Figure 4-1C illustrates a basic bridge circuit for series capacitance (Cs LOW D) measurements. For parallel capacitance measurements with the FUNCTION control set to Cp AUTO, the basic bridge circuit is shown in Figure 4-1D.

4-13. BASIC CIRCUITS FOR INDUCTANCE MEASUREMENTS.

4-14. Figure 4-1E illustrates the basic bridge circuit for series inductance (LOW Q) measurements at 1 kHz. Figure 4-1F illustrates the basic bridge circuit for parallel inductance (HIGH Q) measurements at 1 kHz. For series inductance measurements with the FUNCTION switch set to Ls AUTO, the basic bridge circuit is shown in Figure 4-1G.

4-15. RANGE AND FUNCTION SWITCH A100.

(Schematic Diagram, Figure 8-3)

4-16. Assembly A100 consists of RANGE switch S101, FUNCTION switch S102, and a printed circuit board for lead and component connections. The RANGE and FUNCTION switches route signals in the instrument for proper operation. RANGE switch S101 selects the resistor which forms one arm of the bridge circuit for balancing during a measurement. The selected resistor correctly attenuates the applied signal. Capacitors C101 through C105 provide frequency compensation for certain ranges when ac voltages are applied during L or C measurements.

<p>A</p>	<p>Dc Resistance R $R_x = R_a R_b / R_s$</p>	<p>A dc voltage from battery BT1 is applied between bridge points 0 and P. Variable resistors Ra and Rb are adjusted for a zero or null reading on the indicator. With a null condition, voltage drops across bridge arms XP and YP are equal and the bridge is said to be balanced. Thus, the value of unknown Rx can be determined from the basic relationship: $\frac{R_x}{R_a} = \frac{R_b}{R_s}$</p>
<p>B</p>	<p>Parallel Capacitance Cp (HIGH D: 0.05 to 50 at 1 kHz) $C_x = C_t R_b R_a$ $D_x = \frac{1}{2\pi f C_x R_x} = \frac{1}{2\pi f C_t R_c}$ f = frequency</p>	<p>This circuit is similar to the basic R circuit, but note that capacitor Ct is inserted in parallel with Rc (DQ control). Rx, in parallel with unknown capacitor Cx, represents the inherent resistance of any capacitor. A 1 kHz signal replaces the dc voltage used in R measurements. The relationships for this equivalent bridge circuit are given in B.</p>
<p>C</p>	<p>Series Capacitance Cs (LOW D: 0.001~0.12 at 1 kHz) $C_x = C_t R_b R_a$ $D_x = 2\pi f C_x R_x = 2\pi f C_t R_c$ f = frequency</p>	<p>In this mode, Ct is in series with Rc (DQ control) and loss resistance Rx is in series with unknown capacitor Cx.</p>
<p>D</p>	<p>Parallel Capacitance Cp AUTO $C_x = C_t R_b R_a$</p>	<p>This circuit is similar to the circuit of B except that Rc is replaced by Rd. Rd represents a voltage-adjustable resistor which electronically adjusts this bridge arm resistance and eliminates the need for simultaneous bridge adjustment with more than one control. Thus, with the Model 4260A, the capacitance measurement can be made quickly with only the CRL control.</p>
<p>E</p>	<p>Series Inductance Ls (LOW Q: 0.02 to 20 at 1 kHz) $L_x = C_t R_a R_b$ $Q_x = 2\pi f L_x, R_x = 2\pi f C_t R_c$ f = frequency</p>	<p>Unknown inductance Lx has a series resistor Rx which represents the resistance of the coil windings and loss of inductor.</p>
<p>F</p>	<p>Parallel Inductance Lp (HIGH Q: 8 ~ 1000 at 1 kHz) $L_x = C_t R_a R_b$ $Q_x = \frac{R_x}{2\pi f L_x} = \frac{1}{2\pi f C_t R_c}$ f = frequency</p>	<p>This circuit is similar to the series inductance equivalent circuit, except that loss resistance Rx is in parallel with Lx and Ct is in series with Rc (DQ control).</p>
<p>G</p>	<p>Series Inductance Ls AUTO $L_x = C_t R_a R_b$</p>	<p>This circuit is similar to E except that Rc is replaced by Rd. Rd represents a voltage-adjustable resistor which electronically adjusts this bridge arm resistance and eliminates the need for simultaneous bridge adjustments with more than one control. Thus, with the Model 4260A, the inductance measurement can be made quickly with only the CRL control.</p>

Figure 4-1. Basic Bridge Circuits

4-17. FUNCTION switch S102 routes signals to and from various functional circuits in the instrument. When set to R position, 40 Vdc is routed through S102 and RANGE switch S101 to the unknown R. For L measurements, the bridge arm connections to the DQ and CRL controls are reversed from that for C measurements. This technique maintains the same phase relationship for the bridge error signal and the reference voltage for the AUTO null circuit. The CRL direction indicator lights are also energized for Cp AUTO or Ls AUTO position of the FUNCTION switch. R110 and R111 are fixed bridge resistors selected by FUNCTION switch S102.

4-18. POWER SUPPLY AND 1 kHz OSCILLATOR A200.

(Schematic Diagram, Figure 8-4)

4-19. Assembly A200 includes four power supply sections which generate operating dc voltages and also a 1 kHz oscillator circuit. The +13 Vdc and -12 Vdc outputs are regulated and the +40 Vdc and +110 Vdc outputs are not. The oscillator circuit generates the 1 kHz signal for driving the instrument bridge circuit during L or C measurements.

4-20. POWER SUPPLY.

4-21. PRIMARY POWER. As shown in the schematic of Figure 8-4 , either 115 Vac or 230 Vac is applied through fuse F1 and LINE switch S1 to T1 primary. Rear-panel 115/230 switch S2 connects T1 primaries in parallel for 115 Vac operation or in series for 230 Vac operation.

4-22. +13 VDC SUPPLY. The regulated -13 Vdc supply consists of full-wave rectifier CR201, CR202 whose output is smoothed by C201, regulated by Q201, Q202, Q203, and further filtered by C203. Breakdown diode CR203 provides a 12.7 volt reference at Q203 emitter. Output voltage variations are sensed at Q203 base, amplified, and supplied to driver Q202 base. Q202 then controls regulator Q201 to oppose the output voltage change. Resistor R204 across Q201 collector-emitter provides protection for Q201 when the +13 Vdc output is overloaded.

4-23. -12 VDC SUPPLY. The regulated -12 Vdc supply consists of half-wave rectifier CR204 whose output is smoothed by C204, regulated by Q204, and further filtered by C205. Breakdown diode CR205 provides a 12.7 volt reference at Q204 base. When the output voltage starts to change, this change is sensed by regulator Q204 which changes its dynamic resistance to oppose the voltage change.

4-24. +40 VDC SUPPLY. The unregulated +40 Vdc supply consists of half-wave rectifier CR206 whose output is filtered by the RC combination of R207 and C206. Series resistor R207 limits the output voltage to the UNKNOWN terminals during R measurements.

4-25. +110 VDC SUPPLY. The unregulated +110 Vdc supply consists of half-wave rectifier CR207 whose output is filtered by C207. This +110 Vdc is supplied via pin P, FUNCTION switch S102, and RANGE switch S101 to the decimal point and direction indicator neons.

4-26. 1 kHz OSCILLATOR.

4-27. Transistors Q205, Q206, and associated components form a 1 kHz oscillator circuit. Emitter follower Q207 provides the buffered 1 kHz output to transformer T2 to drive the bridge circuit for L and C measurements. The oscillator is an RC type with positive feedback from Q206 collector to Q205 base to maintain oscillations. Operating frequency is primarily determined by C209, C210, R208, R209, and R210. Variable resistor R210 permits frequency adjustment. R213 is the output level control. Plus 13 Vdc is supplied from pin D via OSCILLATOR INT-EXT switch S3 to pin U. Thus, the oscillator circuit is energized only when S3 is set to INT. Capacitors C208 and C214 filter 1 kHz from the +13 Vdc line.

4-28. REFERENCE VOLTAGE ASSEMBLY A300. (Schematic Diagram, Figure 8-5)

4-29. INTRODUCTION.

4-30. The circuits of assembly A300 receive the 1 kHz signal from bridge transformer T2 and generate a negative output pulse. The duration of this pulse is equal to twice the phase angle (θ) between the bridge driving signal from T2 and the 1 kHz signal across one arm of the bridge circuit. This 2θ pulse duration thus represents a phase relationship in part of the bridge circuit and is used to detect the error signal component in phase with the reference voltage of the phase detector. Detector output drives the voltage-controlled resistor automatically for bridge balance. This automatic action occurs when the FUNCTION switch is set to Cp AUTO or Ls AUTO. The 2θ relationship is used because it provides maximum null resolution and stability for the loop circuit.

4-31. REFERENCE PHASE CIRCUITS.

4-32. The reference phase circuits reconstruct the bridge driving signal from T2 and compose a 1 kHz square wave which is in phase with this driving source. This reference square wave is applied to the phase comparator. The reference phase circuits include high-impedance amplifier No. 1 (Q305, Q306), differential amplifier (Q303, Q304), and limiting amplifier Q307.

4-33. The 1 kHz signal from T2(4) and switch assembly A100 is applied at A300(9). From pin 9 the signal is ac coupled through C307 to Q306 base. Q306 and Q305 amplify the signal current and apply it to differential amplifier transistor Q304. Capacitor C305 is selected to provide positive feedback to Q306. This compensates input capacitance of the amplifier and stray capacitance of CRL resistor R3. The other input to the differential amplifier is from Q301 emitter, which is the other signal from the bridge circuit. Thus the differentially summed output at Q303 collector is a reconstructed sine wave in phase with the bridge driving signal. From Q303 collector, the sine wave is ac coupled through C309 to Q307 base. Diodes CR301, CR302 limit peaks, so the output from Q307 collector is a squared wave. This squared wave is ac coupled through C317 to the phase comparator circuit.

4-34. VARIABLE PHASE CIRCUITS.

4-35. The variable phase circuits receive an ac voltage from one arm of the bridge circuit and supply a square wave which is out of phase with the bridge driving signal at T2. The variable phase circuits include high-impedance amplifier No. 2 (Q301, Q302) and limiting amplifiers Q308 and Q309.

4-36. The 1 kHz signal from T2(3) and switch assembly A100 is applied at A300(7). From pin 7 the signal is ac coupled through C301 to Q301 base. Q301 and Q302 amplify the signal and supply it to limiter amplifier Q308. (From Q301 emitter, the signal is also supplied to Q303 base in the reference phase circuit.) Diodes CR303, CR304 limit signal peaks, so Q309 input is a clipped sine wave. Limiting amplifier Q309 and diodes CR305, CR306 further limit peaks, so Q309 output is a square wave. This square wave is the second input to the phase comparator circuit.

4-37. PHASE COMPARATOR.

4-38. Phase comparator Q310, Q311 receives two square wave inputs: 1) one from the reference phase circuits which is in phase with the bridge driving signal, and 2) a second from the variable phase circuits which has a phase relationship θ with the bridge driving signal. The phase comparator output at Q311 collector is a negative pulse whose duration is equal to phase angle θ .

4-39. The phase comparator acts as an AND gate; that is, when the variable-phase square wave input at Q310 base is positive-going and the reference square wave at Q311 base is negative-going, a negative pulse results at Q311 collector. This negative pulse is θ wide; that is, its duration is equal to the phase difference between the two phase comparator inputs.

4-40. MILLER INTEGRATOR.

4-41. The Miller integrator circuit receives the negative pulse from the phase comparator and generates a positive "A" shaped waveform. The duration of the "A" shaped pulse is twice that of the input negative pulse. C318 is the integrating capacitor.

4-42. SWITCH.

4-43. Transistor switch Q313 makes a square wave from the "A" shaped input pulse. The square wave output duration is equal to the input pulse duration. Q313 is normally off. When the input pulse starts, Q313 saturates and remains on until the input pulse returns to its base line value. The switched output is supplied at pin 15 to drive the one-shot multivibrator on detector assembly A400.

4-44. DETECTOR ASSEMBLY A400.
(Schematic Diagram, Figure 8-6)

4-45. INTRODUCTION.

4-46. Assembly A400 circuits receive the bridge unbalance information and the 2θ pulse from reference voltage assembly A300. These inputs are used to automatically adjust a variable resistance circuit

which replaces a resistance in one arm of the bridge for C_p AUTO or L_s AUTO functions. In addition, these inputs are used to control the direction indicator lights. The right or left direction light is on, depending on which way the CRL control must be rotated to balance the bridge. Detector circuits include the error signal amplifier, phase detector, one-shot multivibrator, differential amplifier, Miller integrator, variable resistance circuit, and CRL direction light control.

4-47. ERROR SIGNAL AMPLIFIER.

4-48. This 80 dB amplifier includes transistors Q401 through Q405 and associated components. Input at pin 1 is a 1 kHz sine wave (if internal oscillator is used; otherwise frequency of external oscillator) whose amplitude represents the amount of bridge unbalance (error signal). Sine wave outputs from Q404 drive part of the phase detector and also the meter circuit. An output from Q405 emitter (phase-shifted 90° leading) drives that part of the phase detector which controls the direction indicator light circuit. Thus, when an unknown L or C is connected across the UNKNOWN terminals, the bridge circuit is unbalanced and an error signal results. This causes a meter reading, a direction light to be on, and also controlled value for the variable resistance.

4-49. The error signal is applied at pin 1 and amplified by Q401, Q402, and Q403. Diodes CR402 through CR405 provide limiting at Q402 to obtain logarithmic amplifier characteristics. Also, when oscillator switch S3 is set to INT (pins 6 and 7 shorted), negative feedback occurs from Q404 emitter to Q403 base through a twin T filter. The T filter provides minimum negative feedback at 1 kHz, which peaks the amplifier at this frequency and it effectively becomes a tuned amplifier with overall loop gain maximum. Breakdown diode CR401 in Q403 emitter establishes the dc operating point for this transistor. Q404 is an emitter follower which supplies the amplified error signal to part of the phase detector. Phase-shifting network R420 and C412 cause the output voltage waveform at Q405 emitter to lead the error signal by 90°. Diodes CR406 through CR409 are a full-wave rectifier to provide a dc for the meter which is proportional to bridge unbalance.

4-50. ONE SHOT MULTIVIBRATOR.

4-51. The one-shot multivibrator (OS MV) receives the negative pulse via pin 12 from switching amplifier Q313 and generates 1 kHz square waves. Complementary square waves from both collectors of the OS MV are applied to phase detector diodes CR412 and CR413.

4-52. The quiescent state of the OS MV is Q406 off, Q407 on. RC combination C416, C417, R425 differentiates the positive-going trailing edge of the negative input pulse. The resulting positive pulse at Q406 base turns this transistor on. RC combination R428, C418 determines how long the Q407 off, Q406 on condition exists. Diodes CR410, CR411 provide a speed-up action for the OS MV when it changes states so that the square wave edges are sharpened.

4-53. PHASE DETECTOR.

4-54. The phase detector circuit receives square waves from the OS MV and sine wave from the error signal amplifier. A varying dc output results at R435, R436 junction which is proportional to bridge unbalance. The phase detector is actually two phase detecting circuits: one for the variable resistance circuit, and a second for the CRL direction light control circuit.

4-55. The error signal sine wave from Q404 emitter is applied through C411 to CR412, CR413 junction. The complementary square waves from the OS MV are applied through R433 and R434 to the other ends of these diodes. When Q406 collector is positive (-4.4 volts), and Q407 collector is zero, diodes CR412 and CR413 conduct. Error signal amplifier output voltage appears at R435, R436 junction without attenuation. When Q406 collector voltage is zero and Q407 collector is -4.4 volts, CR412 and CR413 are cut off; error signal amplifier output voltage does not appear at R435, R436 and this junction is the same voltage level as the average voltage level of -2.2 volts. The voltage level at R430, R431 junction is the average level of -2.2 volts. Thus the differential output between R435, R436 junction and R430, R431 junction is the synchronized rectified output of the error signal. This output is supplied to Q408 for proportional control of the variable resistance circuit.

4-56. Operation of the CR414, CR415 light control section of the phase detector is similar, except that the error signal sine wave is phase-shifted 90° ahead by R420, C412, Q405 combination. When the bridge is unbalanced with the CRL counter too low, an error signal is applied and the dc output to the light control differential amplifier is more positive. With the CRL counter too high, output is less positive.

4-57. DIFFERENTIAL AMPLIFIER AND MILLER INTEGRATOR.

4-58. This circuit uses the phase detector output to control the variable resistance circuit. The Miller integrator provides stability for the overall feedback loop near null or bridge balance when most sensitivity is required. The differential amplifier output at Q408 collector is a dc level which changes with the phase detector input at Q408 base. Integrator circuit Q410 and C420 amplifies Q408 output and stabilizes control of the variable resistance circuit. Near null or bridge balance point, noise and random variations are minimized by the integrator circuit.

4-59. VARIABLE RESISTANCE CIRCUIT.

4-60. The variable resistance circuit includes -6 Vdc regulator Q415, phase splitter Q411, and emitter followers Q412, Q413, Q414. Diodes CR419, CR420 are the heart of the variable resistance circuit, with their bias state controlling their resistance. In Cp or Ls AUTO position, this controlled resistance becomes the R value which replaces the DQ control in one arm of the bridge (see Block Diagram, Figure 8-2).

4-61. Phase splitter Q411 conduction controls CR419, CR420 bias through emitter followers Q412, Q413, and Q414. When Q411 base voltage decreases, current through R446 and R447 decreases; base voltage levels of Q412 and Q413 increase, and the forward current through CR419, CR420 increases. This causes the effective resistance of the diodes to become smaller. When Q411 input voltage causes Q411 to be cut off, current begins to flow through CR416, CR417, and CR415; base voltage level of Q412 and Q413 cannot increase. At this time, diodes CR419, CR420 have the minimum resistance for the bridge arm. When Q411 base voltage increases, Q411 turns on and Q411 collector to emitter voltage becomes small. Diodes CR419, CR420 are cut off and their effective resistance becomes several hundred megohms. Thus, the variable resistance circuit changes its resistance as controlled by bridge balance information from the phase detector.

4-62. DIFFERENTIAL AMPLIFIER AND LAMP DRIVER.

4-63. This circuit uses information from the phase detector circuit (Paragraph 4-56) to light the correct CRL direction lamp. Figure 4-2 is a simplified diagram of the light control circuit. The error dc level at Q416 base is added with the reference level at Q417 base by the differential amplifier to give a resulting dc level at driver Q418 base. When the CRL control is set too low for bridge balance, Q416 is turned on; this causes Q418 to be off with its collector voltage rising to near +110 volts, and right CRL light V602 is energized through R456. With the CRL control too high, Q416 is off, Q418 is on, and left CRL light V601 is energized through R457, Q418, and R455.

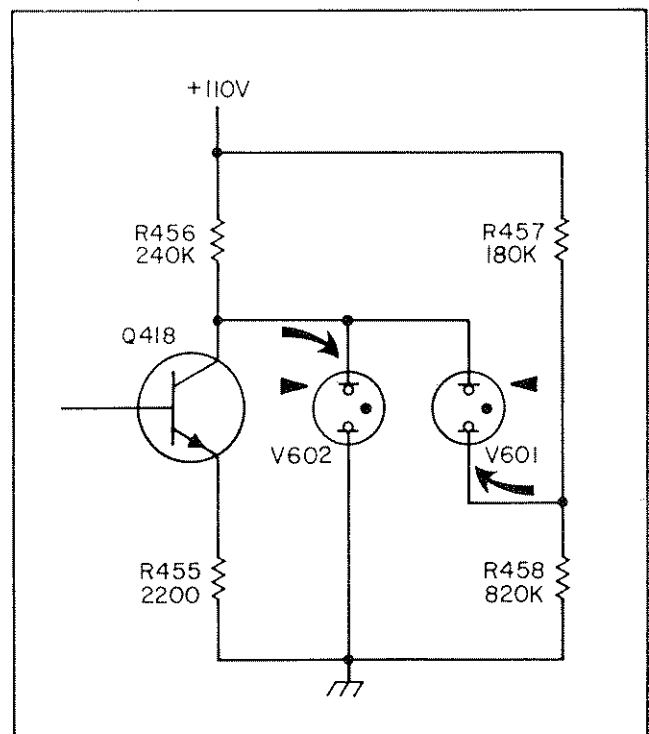

Figure 4-2. CRL Light Control

4-64. CHASSIS ASSEMBLY A500.

4-65. Chassis assembly A500 consists of the main mounting plate (top deck and rear panel) and those parts that are permanently riveted on it. These parts are identified as: J1, ac power input jack; J2, 18-pin connector for printed circuit assembly A200; J3, 15-pin connector for printed circuit assembly A300; J4, 15-pin connector for printed circuit assembly A400; and S2, 115/230 volt ac power slide switch.

4-66. DECIMAL POINT AND DIRECTION INDICATOR LAMP A600.

(Schematic Diagram, Figure 8-3)

4-67. This assembly includes decimal point neons V603, V604, V605, series resistor R601 and CRL direction neons V601, V602. Decimal point lights are controlled by the position of the RANGE and FUNCTION switches. CRL direction light control is explained in Paragraph 4-63.

SECTION V MAINTENANCE

5-1. INTRODUCTION.

5-2. This section provides maintenance and adjustment information for the Model 4260A. The section contains four areas of information as follows:

- a. performance checks are included in Table 5-2 to verify operation of instrument circuits;
- b. troubleshooting and repair information is intended to aid systematic troubleshooting and repair;
- c. adjustment procedures are given in the order recommended for use; these adjustments include checks of critical components in the bridge circuit and also selection procedures for factory-selected components;
- d. operation checks of printed circuit assemblies.

5-3. TEST EQUIPMENT.

5-4. Recommended test equipment for performing the checks and adjustments outlined in this section is listed in tabular form with the procedure to be performed. Test instruments other than those listed can be used if their specifications equal or exceed the listed characteristics.

5-5. INSTRUMENT COVER REMOVAL.

5-6. To remove top or bottom cover, remove two screws at rear of cover, slide cover toward rear of instrument, and lift cover off. Slide covers are removed by taking out four screws in each cover and lifting cover off.

WARNING

115 or 230 volt ac terminals are exposed when bottom or side covers are removed. Exercise caution during troubleshooting, adjustments, or repair. To avoid damage, disconnect power during adjustment or repair.

5-7. ASSEMBLY IDENTIFICATION.

5-8. Table 4-1 lists the assemblies in the Universal Bridge. Assemblies are identified by assembly number: for example, A200.

5-9. PERFORMANCE CHECK.

5-10. Performance checks outlined in Table 5-2 can be used as an operating check for the instrument. These checks can also be used:

- a. as part of an incoming inspection check of instrument specifications;
- b. periodically, for instruments used in systems where reliability is of utmost importance;
- c. as part of a troubleshooting procedure to locate operation problems, and
- d. after any repairs or adjustments, before returning instrument to regular service.

Table 5-1. Performance Check
Test Equipment

Recommended Unit	Model or Part Number
C: 1 μ F \pm 0.2%, sil mica	YHP CS-1
C: 0.1 μ F \pm 0.2%, sil mica	YHP CS-0.1
C: 0.01 μ F \pm 0.2%, sil mica	YHP CS-0.01
C: 1000 pF \pm 0.2%, air	YHP CS-1000A
C: 100 pF \pm 0.2%, air	YHP CS-100A
C: 10 pF \pm 2.5%, 500 WV, cer	0160-0488
C: 1 pF \pm 10%, 500 WV, mica	0150-0029
L: 1 mH \pm 0.5%	YHP SI-1
L: 10 mH \pm 0.2%	YHP SI-10
L: 100 mH \pm 0.2%	YHP SI-100
These resistors can be used for resistance (R) and dissipation factor (D) checks. One per cent resistors are used with capacitors for D checks and 1/2% (or better) are used for resistance checks.	
carb flm, 10 M, 1/4% 1W	0760-0025
met flm, 1 M 1/2%, 1/2W	0757-0017
met flm, 99K, 1/2%, 1/2 W	0757-0010
carb flm, 29.9K 1%, 1/2W	0727-0185
carb flm, 15K 1%, 1/2W	0727-0168
met flm, 10K 1/2%, 1/4W	0698-4203
ww 7.5K 1/4%, 1/8W	0811-0046
met flm, 5K 1/4%, 1/8W	0698-3237
carb flm, 3K, 1%, 1/2W	0727-0124
ww, 2K, 1/2%, 1/2W	0811-0285
carb flm, 1.5K, 1%, 1/2W	0727-0110
carb flm, 1K, 1/2%, 1/2W	0727-0451
carb flm, 300 Ω , 1%, 1/2W	0727-0065
met flm, 150 Ω , 1%, 1/8W	0757-0284
met flm, 100 Ω , 1/4%, 1/2W	0757-1012
carb flm, 33 Ω , 1%, 1/2W	0727-0965
carb flm, 30 Ω , 1%, 1/2W	0727-0991
ww, 9 ohms, 1/2%, 1/2W	0811-0294
carb flm, 7.5 Ω , 1%, 1/2W	0727-0705
ww, 1.1 Ω , 1/2%, 1/2W	0811-0284
DC Null Voltmeter	HP 413A
Range: 1 mV to 300 Vrms	
Input R: 1 megohm	
AC Voltmeter	HP 403B
Range: 1 mV to 10 V	
Input Impedance: 1 megohm	
Electronic Counter	HP 5245L with
Sensitivity: 50 mV	HP 5261A
Freq: Dc to 100 kHz	Plug-In
Display: 4 digits minimum	

Table 5-2. Performance Checks

1. CAPACITANCE MEASUREMENT.

C Range: 1 pf to 1000 μ F; C Accuracy: $\pm (1\% + 1 \text{ digit})$, 1 nF to 100 μ F

D Range: 0.001 to 0.12 for LOW D: 0.05 to 50 for HIGH D

D Accuracy: LOW D -- $\pm \frac{2}{\sqrt{D \text{ of Reading}}}$ %.

HIGH D -- $\pm (10 D \text{ of Reading} + 4)$ %.
- $(10 \sqrt{D \text{ of Reading}} + 2)$ %.

(C greater than 100pF and at 1kHz; an additional error \pm ONE DIAL DIVISION is required at frequencies other than 1kHz.)

a. Connect equipment as shown in Figure 5-1.

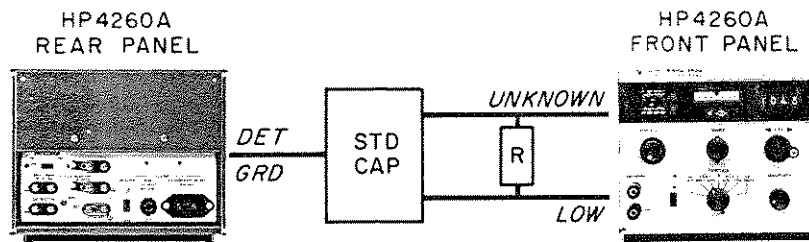

Figure 5-1. Capacitance and D Accuracy Check

b. For this check, locate the following components:

Standard Capacitor	Connect Resistor for Standard D	Function	C Readings	D Readings	C Readings in Cp-AUTO
1 μ F	-	Cs	0989 - 1011 nF	less than 0.002	0984 - 1016 nF
0.1 μ F	-	Cs	098.9 - 101.1 nF	less than 0.002	098.4 - 101.6 nF
0.1 μ F	series 7.5 Ω	Cs	098.9 - 101.1 nF	0.0024 - 0.007	098.4 - 101.6 nF
0.1 μ F	series 30 Ω	Cs	098.9 - 101.1 nF	0.0159 - 0.022	098.4 - 101.6 nF
0.1 μ F	series 150 Ω	Cs	098.9 - 101.1 nF	0.088 - 0.099	097.5 - 100.7 nF
0.1 μ F	parallel 30K Ω	Cp	098.9 - 101.1 nF	0.056 - 0.05	098.4 - 101.6 nF
0.1 μ F	parallel 15K Ω	Cp	098.9 - 101.1 nF	0.112 - 0.1	098.4 - 101.6 nF
0.1 μ F	parallel 3K Ω	Cp	098.9 - 101.1 nF	0.575 - 0.49	098.4 - 101.6 nF
0.1 μ F	parallel 1.5 K	Cp	098.9 - 101.1 nF	1.2 - 0.95	098.4 - 101.6 nF
0.1 μ F	parallel 300 Ω	Cp	098.9 - 101.1 nF	10 - 4	-
0.1 μ F	parallel 33 Ω	Cp	098.9 - 101.1 nF	more than 20	-
0.01 μ F	-	Cs	09.89 - 10.11 nF	less than 0.002	09.84 - 10.16 nF
1000 pF	-	Cs	0979 - 1021 pF	less than 0.002	0974 - 1026 pF
100 pF	-	Cs	0097 - 0103 pF*	less than 0.002	0097 - 0103 pF*
10 pF	-	Cs	0009 - 0011 pF*	-	0009 - 0011 pF*
1 pF	-	Cs	0000 - 0002 pF*	-	0000 - 0002 pF*

*For calibration, subtract residual capacitance from measured value.

- c. Set FUNCTION switch to Cp AUTO.
- d. Connect 1 μ F standard capacitor to UNKNOWN terminals.
- e. Set CRL counter to 1000. Set RANGE switch on nF range to light right decimal point light.

Table 5-2. Performance Checks (cont'd)

f. Rotate CRL control for meter null at center and observe that CRL direction lights change at null position.

g. Set FUNCTION switch to Cs LOW D and adjust DQ dial for meter null. (Slight adjustment of CRL control may give best null.) Read the measured C and D values. These values should be within the values listed above for the standard capacitors.

h. Repeat the procedure for the other standard capacitors listed and connect resistors as indicated.

2. INDUCTANCE MEASUREMENT
 L Range: 1 μ H to 1000 H
 L Accuracy: $\pm (1\% + 1 \text{ Digit})$, from 1 mH to 100 H.
 $\pm (2\% + 1 \text{ Digit})$, from 1 μ H to 1 mH and 100 H to 1000 H.

a. For this check, locate the following inductors:

Standard Inductor	L Readings in Ls-Low Q	L Readings in Ls - AUTO
1 mH	0979 - 1021 μ H	0974 - 1026 μ H
10 mH	09.89 - 10.11 mH	09.84 - 10.16 mH
100 mH	098.9 - 101.1 mH	098.4 - 101.6 mH

Note: Lp: L readings in Lp-High Q should be as follows:

$$L_p = L_s (1 - 1/Q^2)$$

where Ls = L readings in Ls-Low Q

Q = Q readings in Ls-Low Q or Lp-High Q

b. Set FUNCTION switch to Ls AUTO.

c. Connect 1 mH standard inductor to UNKNOWN terminals.

d. Set CRL counter to 1000. Set RANGE switch on μ H range to light right decimal point light.

e. Rotate CRL control for meter null at center and observe that CRL direction lights change at null position.

f. Set FUNCTION switch to Lp LOW D or Ls HIGH D and adjust DQ dial for meter null. (Slight adjustment of CRL control may give best null.) Read the measured L and Q values. These values should be within the values listed above for the standard inductors.

g. Repeat the procedure for the other standard inductors listed.

3. DC RESISTANCE MEASUREMENT.

Range: 10 milliohms to 10 megohms

Accuracy: $\pm (1\% + 1 \text{ digit})$ from 10 ohms to 1 megohm

$\pm (2\% + 1 \text{ digit})$ from 10 milliohms to 10 ohms and 1 megohm to 10 megohms

Residual Resistance: approximately 3 milliohms or less

a. Use an external voltmeter such as the HP 413A DC Null Voltmeter for maximum resolution of the bridge balance point. Remove the shorting strap on the Voltmeter rear panel to isolate the Voltmeter from power line ground. Connect the Voltmeter low or ground input terminal to the 4260A rear-panel DETECTOR ground terminal. Connect the other Voltmeter input terminal to the UNKNOWN LOW terminal on the 4260A.

b. Set the FUNCTION switch to R.

c. Set RANGE switch full cw.

d. Rotate CRL control to 1000.

e. Connect 10 megohm standard resistor to UNKNOWN terminals.

f. Adjust CRL control for null on voltmeter and increase SENSITIVITY control cw for maximum resolution. Read measured R value from CRL counter and decimal point displayed.

g. Repeat the procedure for the other standard resistors.

Table 5-2. Performance Checks (cont'd)

h. Remove resistor from UNKNOWN terminals. With a short, heavy piece of wire, short UNKNOWN terminals. Set RANGE switch full ccw. Measure residual resistance by adjusting CRL control for null indication on Voltmeter. Residual resistance should be less than 1 digit.

Standard Resistors	Model 4260A Readings
Resistor, 10 M Ω \pm 0.5%, 1/4W, metal film	09.79 - 10.21 M Ω
Resistor, 1 M Ω \pm 0.5%, 1/4W, metal film	0989 - 1011 K Ω
Resistor, 100K Ω \pm 0.5%, 1/4W, metal film	098.9 - 101.1 K Ω
Resistor, 10K Ω \pm 0.5%, 1/4W, metal film or WW	09.89 - 10.11 K Ω
Resistor, 7.5K Ω \pm 0.5%, 1/4W, metal film or WW	07.42 - 07.58 K Ω
Resistor, 5K Ω \pm 0.5%, 1/4W, metal film or WW	04.94 - 05.06 K Ω
Resistor, 2K Ω \pm 0.5%, 1/4W, metal film or WW	01.97 - 02.03 K Ω
Resistor, 1K Ω \pm 0.5%, 1/4W, metal film or WW	0989 - 1011 Ω
Resistor, 100 Ω \pm 0.5%, 1/4W, WW	098.9 - 101.1 Ω
Resistor, 10 Ω , \pm 0.5%, 1/4W, WW	09.79 - 10.21 Ω
Resistor, 1 Ω , \pm 0.5%, 1/4W, WW	00.97 - 01.03 Ω

i. To measure the maximum dc voltage at the UNKNOWN terminals for R measurements, connect only a Voltmeter to these terminals.

j. Set FUNCTION to R, RANGE full ccw, and rotate CRL to 1030.

k. Voltmeter should indicate between 30 and 40 Vdc for 115 or 230 volts ac power.

4. INTERNAL OSCILLATOR: Frequency: 1 kHz \pm 2%
Voltage: 100 mV rms \pm 20%

a. Connect equipment as shown in Figure 5-2.

b. Set FUNCTION switch to Ls LOW Q position.

c. Rotate CRL control to 1030.

d. Rotate DQ control full ccw.

e. Read frequency displayed on counter and voltage indicated on voltmeter. Counter should display between 980 Hz and 1020 Hz and meter should indicate between 80 and 120 millivolts rms.

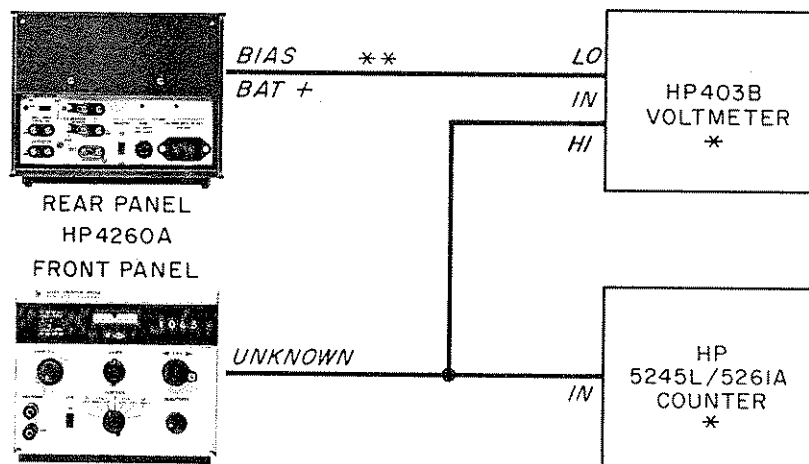

* DO NOT GROUND TO POWER LINE GROUND
** USE SHIELDED CABLE AND CONNECT BIAS BAT + TO UNKNOWN CABLE SHIELD

Figure 5-2. Internal Oscillator Check

PERFORMANCE CHECK TEST CARD

Description	Check
1. Capacitance Measurement	Accuracy $\pm (1\% + 1 \text{ digit})$ <input type="text"/> LOW D $\pm \frac{2}{\sqrt{D \text{ of Reading}}} \%$ <input type="text"/> HIGH D $+ (10 D \text{ of Reading} + 4) \%$ <input type="text"/> $- (10 \sqrt{D \text{ of Reading}} + 2) \%$
2. Inductance Measurement	Accuracy $\pm (1\% + 1 \text{ digit})$ <input type="text"/>
3. Dc Resistance Measurement	Accuracy 10 ohms to 1 megohm $\pm (1\% + 1 \text{ digit})$ <input type="text"/> Accuracy 10 milliohms to 10 megohms $\pm (2\% + 1 \text{ digit})$ <input type="text"/>
4. Internal Oscillator	Frequency 980 Hz <input type="text"/> 1020 Hz Voltage 80 mV rms <input type="text"/> 120 mV rms

11
12
13
14
15
16
17
18
19
20
21
22
23
24
25
26
27
28
29
30
31
32
33
34
35
36
37
38
39
40
41
42
43
44
45
46
47
48
49
50
51
52
53
54
55
56
57
58
59
60
61
62
63
64
65
66
67
68
69
70
71
72
73
74
75
76
77
78
79
80
81
82
83
84
85
86
87
88
89
90
91
92
93
94
95
96
97
98
99
100

17

5-11. TROUBLESHOOTING.

5-12. The best approach to isolating trouble is to first ensure that the trouble is not a result of conditions external to the 4260A; then obtain all possible information from the controls and indicators and logically apply this information to locate the defective unit or component. Figure 3-1 (Controls and Indicators, front panel; Controls and Connectors, rear panel), and component location figures and schematic diagrams can be used to understand operation and locate parts. Table 5-3 lists test equipment required for troubleshooting. Table 5-4 (Troubleshooting) lists possible trouble symptoms and checks for their cause. Table 5-5 shows decimal point and units indication logic. Troubleshooting of printed circuit assemblies is simplified if a suspected assembly is replaced with an operating assembly. Printed circuit operation checks are outlined in Paragraphs 5-39 through 5-51.

5-13. As a general check procedure, the following questions are a guide for isolating trouble:

- a. Are external instruments operating and connected correctly?
- b. Is the unknown component connected correctly?
- c. Are rear-panel shorting straps in place?

5-14. REPAIR.**5-15. COVER AND FRONT PANEL REMOVAL.**

5-16. Instrument covers are removed by taking out screws in each cover. To remove front panel, remove all front-panel knobs and side covers. In Figure 5-3 locate the four screws "A" which hold the side frames; loosen these screws. Carefully pull front panel towards front while holding side frames apart to release panel. Loosen deck side screws also.

5-17. PRINTED CIRCUIT COMPONENT REPLACEMENT.

5-18. To replace components on printed circuit boards, the following procedure is recommended:

- a. Clip leads of defective component and remove.
- b. With toothpick and soldering iron, clean component mounting holes.
- c. Insert replacement component leads into holes. Use heat and solder sparingly and solder leads in place.
- d. Refer to Paragraphs 5-39 through 5-51 for operation checks of printed circuit assemblies.

5-19. CRL COUNTER AND R3 REPLACEMENT.

5-20. CRL COUNTER. To remove this counter, remove two screws "B" in Figure 5-3 and lift out counter. Refer to Paragraph 5-27 (CRL ADJUSTMENTS) before installing counter.

5-21. CRL RESISTOR R3. For R3 replacement, remove CRL knob and four screws "C" in Figure 5-3.

Install replacement R3. Adjustment is required; refer to Paragraph 5-27 (CRL ADJUSTMENTS).

5-22. DQ DIAL AND R5 REPLACEMENT.

5-23. The DQ dial and resistor R5 are installed as a calibrated unit and therefore not separately replaceable. Contact the nearest Hewlett-Packard Sales/Service Office for service assistance (see lists at the back of this manual).

5-24. ADJUSTMENTS.

5-25. 1 kHz OSCILLATOR LEVEL & FREQUENCY. With 4260A top cover removed, connect oscilloscope and electronic counter to pin T of J2. Adjust R213 for level between 4.5 and 6.7 volts peak-to-peak, with positive peak clipped not more than 100 microseconds. Adjust frequency with R210 for 995 to 1005 Hz. Repeat level and frequency adjustments until both are within these values.

5-26. ERROR SIGNAL PHASE AND GAIN. To check phase and gain of the error signal amplifier on detector assembly A400, the test setup of Figure 5-4 is required.

- a. Disconnect the shielded cable from pin 1 of J4.
- b. Connect the equipment as shown in Figure 5-4.
- c. Set 4260A LINE switch to ON.

d. Adjust the oscillator output voltage to 1 volt peak-to-peak on the oscilloscope. Set oscillator frequency to 1000 Hz, ± 1 Hz.

e. Alternately adjust R415 and R417 so that oscillator output voltage and J4 pin 7 voltage are in phase and J4 pin 7 voltage level is between 0.9 and 1.1 volt peak-to-peak.

f. Turn off 4260A LINE switch and disconnect equipment. Connect shielded cable to J4 pin 1. This completes the adjustment.

5-27. CRL COUNTER ADJUSTMENT.

- a. Remove power cable from the 4260A to unground the instrument.
- b. Disconnect shielded cable from CRL resistor R3.
- c. Set CRL counter to 0001.
- d. Loosen screws "B" in Figure 5-3 and separate counter gear from gear train.
- e. With a 1% meter or another 4260A with external null meter, adjust resistance of R3 to be 5.0 ohms.
- f. Set CRL counter to 0001 and engage counter with gear train.
- g. Tighten screws loosened in step d and check to ensure that CRL control operates gear train easily without slippage. If too stiff, loosen screws and readjust.
- h. Connect shielded cable to R3. This completes the adjustment.

Table 5-3. Test Equipment Required for Troubleshooting

Item	Description	HP Model
Dc Voltmeter	Range: 1 mV to 300 Vdc Input R: 1 megohm	413A
Oscillator	Frequency: 20 Hz to 20 kHz Output Level: 2 volts rms max.	200CD
Oscilloscope	Vertical Sensitivity: 50 mV/cm	175A with 1780A Horizontal and 1750B Dual Trace Vert. Ampl. Plug-ins.
Standard Components	See Table 5-1, Performance Check Test Equipment	

Table 5-4. Trouble Symptoms and Possible Causes

Symptom	Normal Operation	Possible Cause	Check
No lamps light	One of the decimal point indicator lamps should light when the 4260A is turned on.	Fuse blown Defective lamps +110V supply Switch contacts	Fuse Lamps Power supply - CR207 S101, S102
No meter deflection for R measurements	Meter should deflect either right or left when S102 set to R position.	Defective meter circuit 40V dc supply Switch contacts Bridge circuit	Meter, CR1, CR2 Power supply - CR206 S101, S102 R3, R110
No meter deflection for C & L measurements	Meter should deflect right when S102 set to Cs, Cp, Cp AUTO, Ls AUTO, Ls or Lp position.	1 kHz oscillator Error signal amplifier Switch contacts Bridge circuit	Oscillator - Q205 to Q207 Amplifier - Q401 to Q405 S101, S102, S3 C1, R3 to R5
Noisy null or no bridge null obtained for R measurements	Bridge null should be obtained when S102 is set to R position	Switch contacts Bridge circuit	S101, S102 R3, R101 to R110 C101 to C105
Noisy null or no bridge null obtained for C and L measurements (without AUTO)	Bridge null should be obtained when S102 set to Cs, Cp, Ls or Lp position.	Switch contacts Bridge circuit Error signal amplifier oscillation High impedance amplifier oscillation	S101, S102, S3 C1, R3 to R5, R101 to R109, R111, C101 to C105 Amplifier - Q401 to Q405 Amplifier - Q301, Q302, Q305, Q306
Noisy null or no bridge null obtained for C AUTO and L AUTO measurements	Bridge null should be obtained when S102 set to Cp AUTO or Ls AUTO position.	Switch contacts Auto null circuits	S102 Check voltages and waveforms to determine faulty circuit
Abnormal operation on direction indicator. Auto null obtained properly.	Direction indicator light should shift from left to right or from right to left in the vicinity of bridge null.	Switch contacts Neon lamp driver Differential amplifier Phase detector Error signal amplifier	S103, S3 Q418 Q416, Q417 CR414, CR415 Q405
Display out of specifications (not AUTO measurements)	CRL and DQ readings within specifications.	Switch contacts Bridge circuit Low impedance of high impedance amplifier	S101, S102 R3 to R6, R101 to R111, C1 to C4, C101 to C105 Amplifier - Q301, Q302 Amplifier - Q305, Q306
Display in AUTO measurements out of specifications	CL readings in AUTO measurements within specifications.	Variable resistance circuit.	Q411 to Q414, CR416 to CR420, C421, L401

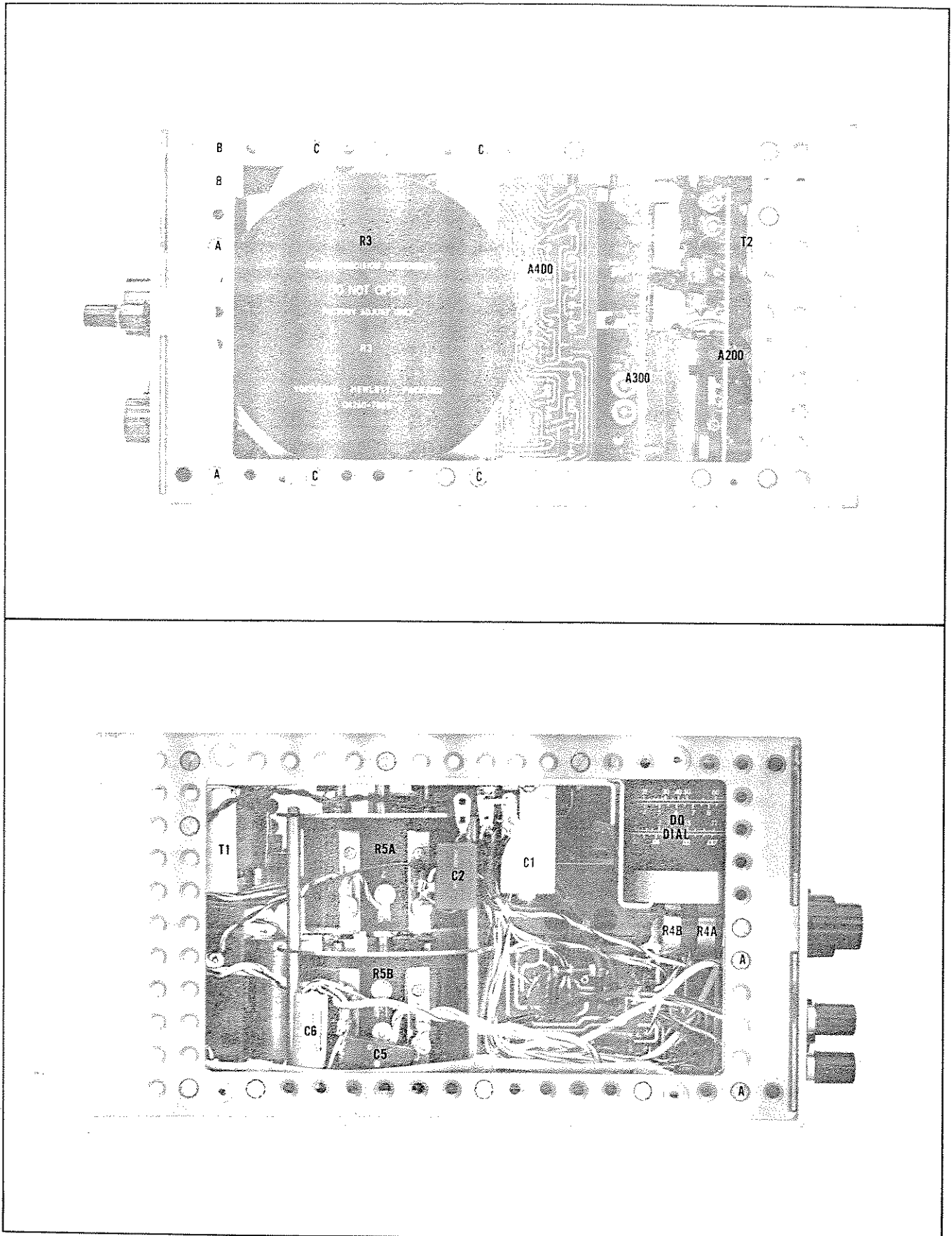

Figure 5-3. Right and Left Side Internal Component Location

Table 5-5. Decimal Point and Units Indication Logic

Function S102 Range S101	Cs LOW D (ccw)	Cp HIGH D	Cp AUTO	R				Ls AUTO	Ls LOW Q	Lp HIGH Q (cw)		
	Decimal Lights			Units	Decimal Lights			Units	Decimal Lights		Units	
1 (ccw)	OFF	OFF	ON	μ F	ON	OFF	OFF	Ω	OFF	OFF	ON	μ H
2	OFF	ON	OFF	μ F	OFF	ON	OFF	Ω	ON	OFF	OFF	mH
3	ON	OFF	OFF	μ F	OFF	OFF	ON	Ω	OFF	ON	OFF	mH
4	OFF	OFF	ON	nF	ON	OFF	OFF	k Ω	OFF	OFF	ON	mH
5	OFF	ON	OFF	nF	OFF	ON	OFF	k Ω	ON	OFF	OFF	H
6	ON	OFF	OFF	nF	OFF	OFF	ON	k Ω	OFF	ON	OFF	H
7 (cw)	OFF	OFF	ON	pF	ON	OFF	OFF	M Ω	OFF	OFF	ON	H

5-28. DQ DIAL MECHANICAL ZERO.

a. With instrument power off and top cover removed, rotate DQ control full ccw.

b. Loosen two allen drive setscrews on R5 pulley.

c. Rotate DQ control ccw until the black line on the right off-scale end of DQ dial aligns with red index line on front panel window. Dual wire-wound resistor R5A, B should also be full ccw.

d. Tighten two setscrews. This completes the adjustment.

5-29. BRIDGE CIRCUIT COMPONENT CHECKS.

5-30. INTRODUCTION. The procedures in Paragraphs 5-31 through 5-38 outline checks and adjustments for the components in the bridge circuit. These include fixed 0.2 μ F capacitor C1, compensating capacitor C305, CRL resistor R3, trimmers C103, C104, C3, and accuracy of resistors in the RANGE switch. The test equipment setup is shown in Figure 5-5. These checks and adjustments should be performed in the order listed when a comprehensive over-all instrument checkout is desired. Test equipment for these checks is listed in Table 5-6.

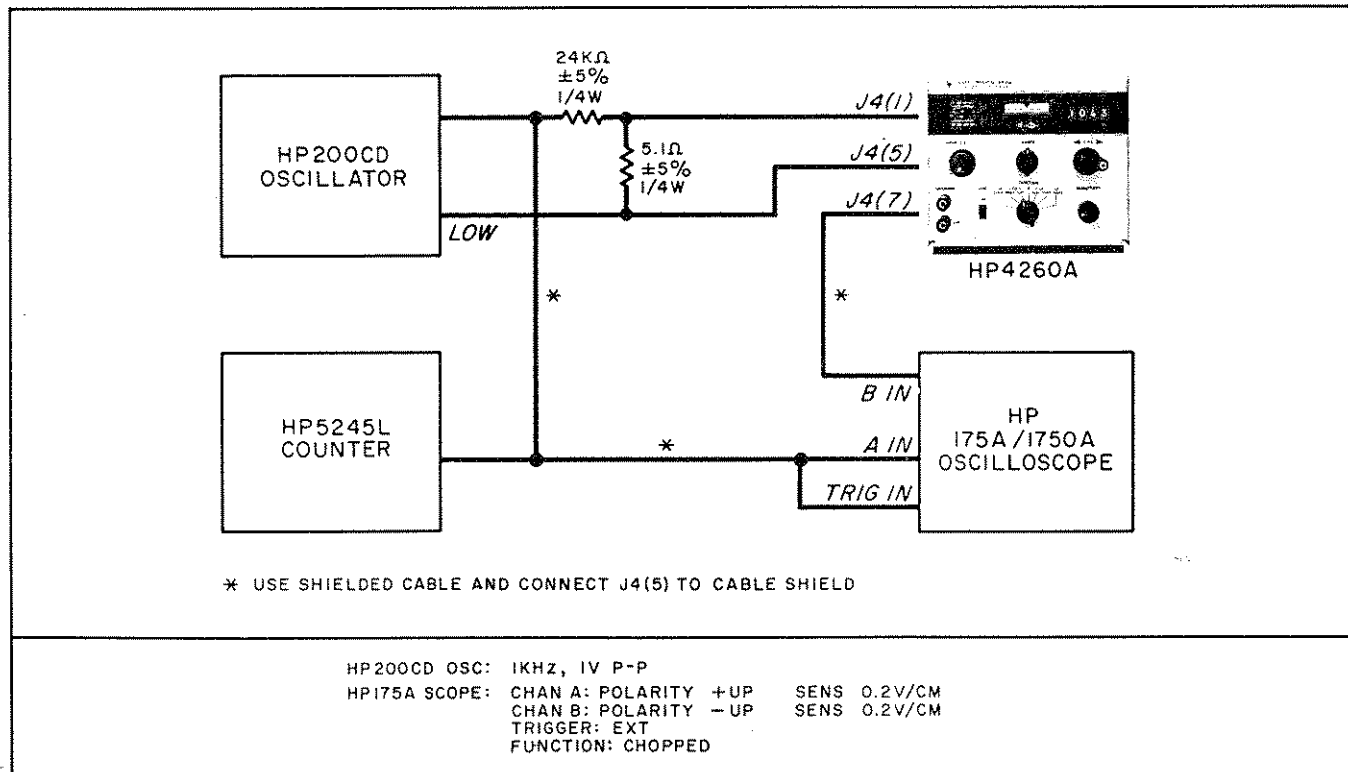

Figure 5-4. Error Signal Amplifier Phase and Gain Test Setup

Table 5-6. Test Equipment for Bridge Circuit Checks.

ITEM	DESCRIPTION	MODEL OR PART NO.
Oscillator	Frequency: 20 Hz to 20 kHz Output Level: 2 volts rms	200CD
Oscilloscope	Vertical Sensitivity: 100 $\mu\text{v}/\text{cm}$	140 A with 1400A Diff. Ampl. plug in
Standard C	0.1 microfarad, $\pm 0.1\%$	YHP CS-0.1
Silvered Mica C	0.01 microfarad, $\pm 0.2\%$	YHP CS-0.01
Silvered Mica C	1000 picofarads, $\pm 1\%$	YHP CS-1000A
Standard L	1 millihenry, $\pm 0.1\%$	General Radio 1482-E
Resistance Bridge	Range: 10 ohms to 10K ohms Accuracy: $\pm 1\%$	HP 4260A
Resistors	fxd, comp, 16 ohms, $\pm 5\%$, 1/2 W fxd, comp, 16K ohms, $\pm 5\%$, 1/4 W fxd, comp, 33 ohms, $\pm 5\%$, 1/4 W fxd, comp, 160K ohms, $\pm 5\%$, 1/4 W fxd, comp, 330 ohms, $\pm 5\%$, 1/4 W fxd, comp, 1.6 Meg, $\pm 5\%$, 1/4 W fxd, comp, 3.3K ohms, $\pm 5\%$, 1/4 W Met film, 15.9K ohms, $\pm 0.5\%$; use 14K ohms, $\pm 0.25\%$ and 1.91K ohms, $\pm 1\%$	0686-1605 0683-1635 0683-3305 0683-1645 0683-3315 0683-1655 0683-3325 0698-3371 0698-4631

5-31. C1 CHECK. To check fixed bridge capacitor C1, connect the instruments as shown in Figure 5-5.

a. Connect a standard 0.1 μF capacitor such as the YHP Model Cs-0.1 and a 16 ohm 5% 1/4 watt resistor (HP #0686-1605) in series across the UNKNOWN terminals. The guard terminal of the standard capacitor should be connected to the rear-panel ground terminal of the DETECTOR jack.

b. Set FUNCTION switch to Cs LOW D.

c. Set RANGE switch to display XXX.X nF.

d. Set rear-panel INT-EXT switch to EXT and set oscillator to 1 kHz.

e. Balance the bridge and read the measured C value. C value should be: standard value $\pm 0.3\%$; for example 099.7 to 100.3 nF.

5-32. C305 SELECTION. Capacitor C305 compensates for amplifier stray input capacity and the capacity of the CRL control. The procedure for selecting the correct value for C305 is as follows:

a. Connect the test setup as shown in Figure 5-5.

b. Connect a standard capacitor such as the YHP Model CS-0.1 μF and a 16K ohm $\pm 5\%$ 1/4 watt resistor in parallel to the UNKNOWN terminals.

c. Set FUNCTION switch to Cp HIGH D.

d. Set RANGE switch for XXX.X nF display.

e. Set rear-panel INT-EXT switch to EXT and set oscillator to 1 kHz.

f. Balance the bridge and read measured C value. Measured C = ____ . __ nF.

g. Disconnect the parallel 16K ohms resistor from the UNKNOWN terminals. Connect a 33 ohms 5% 1/4 watt resistor in parallel with the standard capacitor.

h. Change oscillator frequency to 20 kHz.

i. Balance the bridge and read measured C value. Measured C = ____ . __ nF.

j. Calculate the difference between 1 kHz value and 20 kHz value (steps f and i). Difference should be within ± 0.2 nF. If not within this tolerance, change value of C305 and repeat.

5-33. CRL RESISTANCE (R3) AT 500 OHMS. For maximum accuracy during measurements, CRL resistor R3 should introduce no errors. C305 selection provides high frequency compensation at the high resistance end of R3. The R3 check at 500 ohms is an additional check to ensure that R3 resistance is correct.

a. Connect test equipment setup as shown in Figure 5-5.

b. Connect the 0.01 μF silvered mica capacitor with a 160K ohms $\pm 5\%$ 1/4 watt resistor in parallel to the UNKNOWN terminals.

c. Set FUNCTION switch to Cp HIGH D.

- d. Set RANGE switch for XXX. X nF display.
- e. Set INT-EXT switch on rear panel to EXT.
- f. Set Oscillator frequency to 1 kHz.
- g. Balance the bridge and read the measured C value. Measured C = _____. nF.
- h. Disconnect parallel 160K resistor and connect a 330 ohm $\pm 5\%$ 1/4 watt resistor in parallel with the standard silvered mica capacitor.
- i. Change oscillator frequency to 20 kHz.
- j. Balance the bridge and read measured C value. Measured C = _____. nF. Capacitance difference between values obtained in steps g and j should be within a half digit on the CRL counter.

5-34. C103 CHECK AND ADJUSTMENT. Trimmer capacitor C103 is inside switch assembly A100. The adjustment can be done through the access hole in the switch assembly.

- a. Connect test equipment as shown in Figure 5-5.
- b. Connect the 0.01 μ F silvered mica capacitor with a parallel 160K ohms $\pm 5\%$ 1/4 watt resistor to the UNKNOWN terminals.
- c. Set FUNCTION switch to Cp HIGH D.
- d. Set RANGE switch for XX. XX nF display.
- e. Set oscillator INT-EXT switch to EXT. and adjust oscillator frequency to 1 kHz.
- f. Balance the bridge and read measured C value. Measured C = _____. nF.
- g. Disconnect the 160K ohms resistor and connect a 330 ohms $\pm 5\%$ 1/4 watt resistor in parallel with the silvered mica capacitor.
- h. Change oscillator frequency to 20 kHz.
- i. Balance the bridge and read measured C value. Measured C = _____. nF. Difference between C values of steps f and i should be made minimum by adjusting C103.
- j. Adjust C103 slightly and repeat procedure. C103 adjustment is correct when difference between the two measured C values is minimum.

5-35. C104 CHECK AND ADJUSTMENT. Trimmer capacitor C104 is inside switch assembly A100. The adjustment can be done through the access hole in the switch assembly.

- a. Connect test equipment setup as shown in Figure 5-5.
- b. Connect the 1000 pF silvered mica capacitor with a 1.6 megohm $\pm 5\%$ 1/4 watt resistor in parallel to the UNKNOWN terminals.

- c. Set FUNCTION switch to Cp HIGH D.
- d. Set RANGE switch for XXXX. pF display.
- e. Set oscillator INT-EXT switch to EXT. and set oscillator frequency to 1000 Hz.
- f. Balance the bridge and read measured C value. Measured C = _____. pF.
- g. Disconnect the 1.6 megohm resistor and connect a 3300 ohm $\pm 5\%$ 1/4 watt resistor in parallel with the 1000 pF capacitor.
- h. Change oscillator frequency to 20 kHz.
- i. Balance the bridge and read measured C value. Measured C = _____. pF. Difference between C values for steps f and i should be made minimum by adjusting C104.

j. Adjust C104 slightly and repeat procedure. Adjustment is correct when difference between the two measured C values is minimum. This completes C104 adjustment.

5-36. C3 ADJUSTMENT. Trimmer capacitor C3 is adjusted to compensate for transformer T2 capacitance. The procedure is as follows:

- a. Connect test equipment setup as shown in Figure 5-5.
- b. Connect the 0.01 μ F $\pm 0.2\%$ with a parallel 15.9 K ohms $\pm 0.5\%$ 1/4 watt resistor to the UNKNOWN terminals.
- c. Set FUNCTION switch to Cp HIGH D.
- d. Set RANGE switch for XX. XX nF display.
- e. Set oscillator INT-EXT switch to EXT.
- f. Set oscillator frequency to 1000 Hz ± 5 Hz.
- g. Balance the bridge and read measured D value. D reading should be 1 ± 0.05 .
- h. Remove ac power from the 4260A.
- i. Remove shorting strap across Cp Ls DQ RESISTOR terminals on rear panel. With another 4260A measure the dc resistance between the ungrounded Cp Ls DQ RESISTOR terminal and the white-black lead end of C1.
- j. Adjust DQ control so that the second 4260A measures 812 ohms. Disconnect measuring 4260A and connect shorting strap across Cp Ls DQ RESISTOR terminals.
- k. Apply ac power to 4260A.
- l. Without moving DQ control, balance the bridge by adjusting CRL control and C3. Adjustment is correct when bridge null is obtained.

5-37. FIRST RANGE CHECK (FULL CCW). The following procedure checks 1 ohm resistor R101 inside the RANGE switch.

- a. Connect test setup as shown in Figure 5-5.
- b. Connect a standard 1 mH inductor such as a General Radio 1482E. The inductor high terminal is connected to the unmarked UNKNOWN terminal and the inductor low and guard terminals should be connected to the UNKNOWN LOW terminal. The inductor case should be isolated from ground.
- c. Set FUNCTION switch to Ls LOW Q.
- d. Set RANGE switch for XXXX. μ H.
- e. Set oscillator INT-EXT switch to EXT and set oscillator frequency to 1 kHz.
- f. Balance the bridge and read the measured L value. Measured L value = _____ μ H.
- g. Install a 330 ohm $\pm 5\%$ 1/4 watt resistor in series between the inductor high terminal and the unmarked UNKNOWN.
- h. Set oscillator frequency to 20 kHz.
- i. Balance the bridge and read measured L value. Measured L value = _____ μ H. Inductance difference between L values obtained in steps f and i should be within $\pm 0005 \mu$ H. If not within 0005, measure the resistance between UNKNOWN LOW terminal and terminal 40 (see Page 8-4) as follows:

- 1) Remove instrument top, bottom, and right side covers. Remove two screws in printed circuit hold-down cover and lift off.

- 2) Remove all three printed circuit assemblies.
- 3) Set FUNCTION switch to Lp LOW Q.
- 4) Remove shorting strap from BIAS BATTERY terminals.
- 5) Measure the dc resistance between UNKNOWN LOW terminal and terminal 40 (Page 8-4). If this value is 1 ohm $\pm 0.5\%$, select C101 for L difference readings within 0005 as discussed in step i. If the R value is not 1 ohm $\pm 0.5\%$, check contacts of S101 and S102.

5-38. SECOND RANGE CHECK. The following procedure checks 10 ohm resistor R102 inside RANGE switch A100.

- a. Connect test setup as shown in Figure 5-5.
- b. Connect a standard 1 mH inductor such as a General Radio 1482E. The inductor high terminal is connected to the unmarked UNKNOWN terminal and the inductor low and guard terminals should be connected to the UNKNOWN LOW terminal. The inductor case should be isolated from ground.
- c. Set FUNCTION switch to Ls LOW Q.
- d. Set RANGE switch for XX.XX mH display.
- e. Set oscillator INT-EXT switch to EXT and adjust oscillator frequency to 1 kHz.
- f. Balance the bridge and read the measured L value. Measured L value = _____ mH.
- g. Disconnect the standard inductor from the UNKNOWN unmarked terminal and connect a 330 ohm 5% 1/4 watt resistor in series.

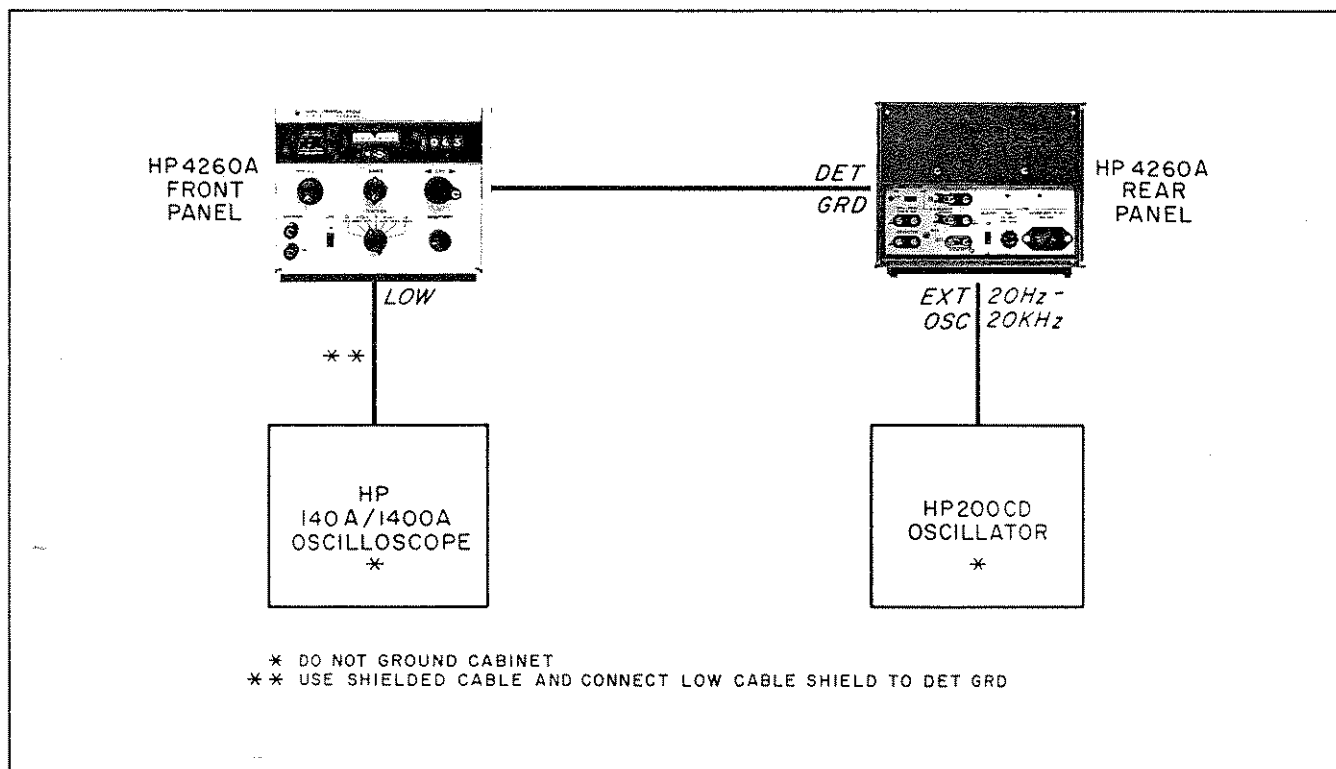

Figure 5-5. Test Setup for Adjustments

h. Set oscillator frequency to 20 kHz.

i. Balance the bridge and read measured L value. Measured L value = _____ mH. Inductance difference between measured L values in steps f and i should be within half a digit. If not within half a digit on the CRL counter, the measured dc resistance of R102 should be $10 \text{ ohms} \pm 0.5\%$ (see Paragraph 5-37, step i).

5-39. OPERATION CHECKS OF PRINTED CIRCUIT ASSEMBLIES.

5-40. The following paragraphs outline operating checks for printed circuit assemblies A200, A300, and A400.

5-41. POWER SUPPLY AND 1 KHZ OSCILLATOR ASSEMBLY A200.

5-42. POWER SUPPLY.

a. With LINE switch ON, connect dc voltmeter to J2 pin D (test point 1). Voltmeter should indicate between +12.0 and +13.5 Vdc.

b. Connect dc voltmeter to J2 pin F (test point 2). Voltmeter should indicate between -11.0 and -12.5 Vdc.

c. Connect dc voltmeter to J2 pin P (test point 3). Voltmeter should indicate between +95 and +115 Vdc.

5-43. 1 kHz OSCILLATOR.

a. With LINE switch ON, set rear-panel oscillator switch to INT.

b. Connect oscilloscope to J2 pin T (test point 4). Voltage level should be between 4.5 and 6.7 volts peak-to-peak. Waveform is shown in Figure 8-4.

c. Connect electronic counter to J2 Pin T. Counted frequency should be between 995 and 1005 Hz.

5-44. REFERENCE VOLTAGE ASSEMBLY A300.

5-45. Operation checks of this assembly are best made by waveforms. Test points 5 through 16, Figure 8-5, indicate waveforms for these circuits to be used with the following procedures. Remove power.

a. Disconnect white-green-blue wire from J4, pin 10, and connect this wire to terminal 3 of DQ resistor R5A.

b. Set FUNCTION switch to Cp AUTO position.

c. Set RANGE switch to display XXX. X nF.

d. Connect a 100 nF ($0.1 \mu\text{F}$) $\pm 5\%$ capacitor (HP 0170-0001) and a 27K ohm $\pm 5\%$ resistor (0689-2735) in parallel across the UNKNOWN terminals.

e. Remove detector assembly A400 and install 15-pin extender board (HP 5060-0049) in A400 jack J4. Observe correct orientation and insert A400 in extender board. Connect oscilloscope to test point 19 (R430, R431 junction).

f. Apply power to 4260A and adjust CRL and DQ controls for minimum amplitude of waveform at test point 19 (bridge balanced). CRL counter should read between 095.0 nF and 105.0 nF and D reading should be between 0.053 and 0.065 on HIGH D scale.

g. With the bridge balanced, the waveforms of Figure 8-5 for test points 5 through 16 should now result. Turn power off and remove reference voltage assembly A300 from J3 and install a 15-pin extender board in J3. Observe correct orientation and insert A300 in 15-pin extender.

h. Apply power, connect oscilloscope to test points 5 through 16 and compare each waveform with those shown in Figure 8-5.

5-46. DETECTOR ASSEMBLY A400.

5-47. Conditions for observing waveforms at test points on A400 are the same as outlined in Paragraph 5-45, steps a through f.

5-48. PHASE DETECTOR CIRCUIT. Waveforms shown in Figure 8-6 for test points 17 and 18 indicate normal operation. The difference between dc voltages at test points 19 and 20, or 19 and 21 is less than 10 millivolts. These voltages must be measured using a dc voltmeter with an input impedance greater than 10 megohms.

5-49. ERROR SIGNAL AMPLIFIER CIRCUIT. Waveforms for test points 22 and 23 are shown in Figure 8-6. The changes at these test points when the CRL control is increased or decreased 0.2% from bridge balance point are shown as 22a, b and 23a, b. These waveforms indicate that error signal amplifier gain is normal and phase relationship is correct.

5-50. VARIABLE RESISTANCE CIRCUIT.

a. Conditions for selecting value of R442 are the same as outlined in Paragraph 5-45, steps a. through f. in the "Operating and Service Manual".

b. Connect resistance network as shown in Fig. 5-6.

c. Connect Oscilloscope Probe (10:1) to Test Point 30 (J4 PIN 10) and set the vertical sensitivity to 0.005v/div (0.05v/div with probe).

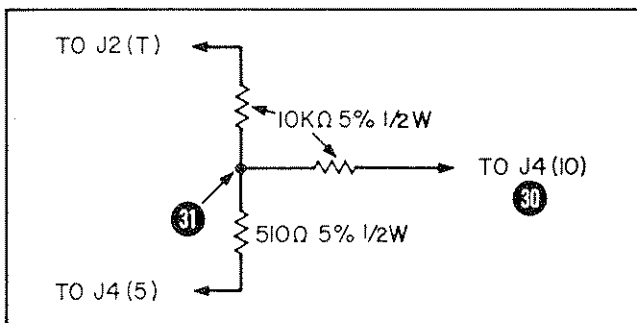

Figure 5-6. Resistance Network for Checks

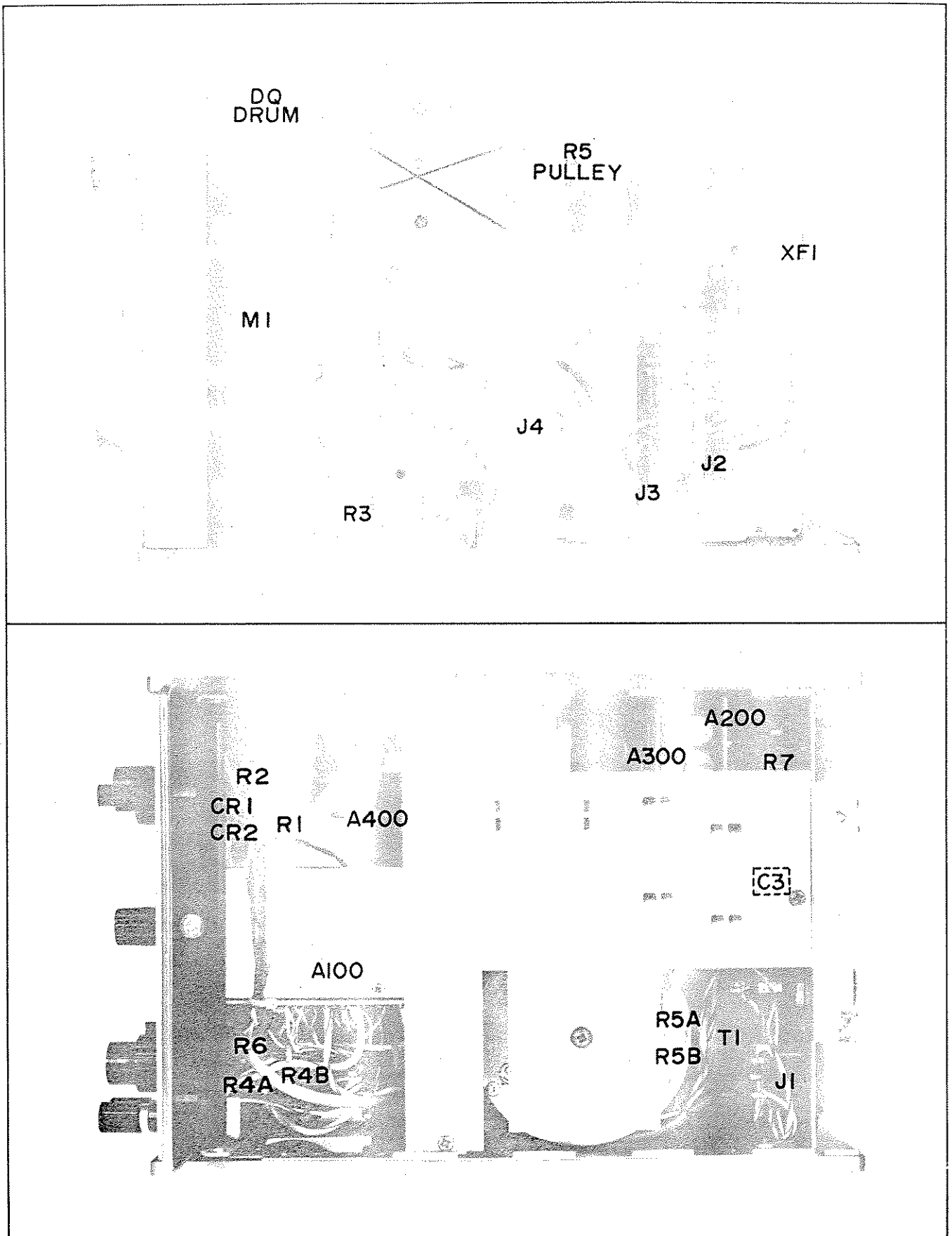

Figure 5-7. Top and Bottom Internal Component Location

d. Adjust CRL and DQ controls for bridge balance (For example, assume the CRL reading is 102.0 nF and D reading is 0.062).

e. Change CRL control to +0.2% from bridge balance point and set CRL counter to 102.2nF. Verify that the 1kHz signal on the oscilloscope is no more than 30 mV p-p.

f. Quickly shift CRL control by -0.2% of balance reading (to 101.8 for above example). Observe the oscilloscope. At first there is no 1kHz signal but after about 10 seconds it will appear.

g. Quickly shift CRL control by +0.270 of balance reading (to 102.2 for above example). After a few seconds the 1kHz will disappear.

h. Select the value of R442 so that the time constants of the changes at Test Point 30 when the CRL control is increased or decreased are almost same. The selected value for R442 is not critical.

5-51. NEON LAMP DRIVER. Dc voltage changes at test points 32 and 33 are shown in Figure 8-6 for a CRL control change of +0.2% or -0.2% from bridge balance point.

SECTION VI REPLACEABLE PARTS

6-1. INTRODUCTION.

6-2. This section contains information for ordering replacement parts. Table 6-1 lists parts in alpha-numerical order of their reference designators and indicates the description and HP stock number of each part, together with any applicable notes. Table 6-2 lists parts in alpha-numerical order of their HP stock number and provides the following information on each part;

- a. Description of the part (see list of abbreviations below).
- b. Typical manufacturer of the part in a five-digit code; see list of manufacturers in Table 6-3.
- c. Manufacturer's part number.
- d. Total quantity used in the instrument (TQ column).

6-3. Miscellaneous parts are listed at the end of Table 6-1.

6-4. ORDERING INFORMATION.

6-5. To obtain replacement parts, address order or inquiry to your local Hewlett-Packard Field Office (see lists at rear of this manual for addresses). Identify parts by their Hewlett-Packard stock numbers.

6-6. To obtain a part that is not listed, include:

- a. Instrument model number.
- b. Instrument serial number.
- c. Description of the part.
- d. Function and location of the part.

REFERENCE DESIGNATORS

A = assembly	E = misc electronic part	P = plug	V = vacuum, tube, neon bulb, photocell, etc.
B = motor	F = fuse	Q = transistor	VR = voltage regulator
BT = battery	FL = filter	R = resistor	W = cable
C = capacitor	J = jack	RT = thermistor	X = socket
CP = coupler	K = relay	S = switch	Y = crystal
CR = diode	L = inductor	T = transformer	
DL = delay line	M = meter	TB = terminal board	
DS = device signaling (lamp)	MP = mechanical part	TP = test point	

ABBREVIATIONS

A = amperes	H = henries	NPN = negative-positive-negative	RMS = root-mean square
A. F. C. = automatic frequency control	HEX = hexagonal	NRFR = not recommended for field replacement	RWV = reverse working voltage
AMPL = amplifier	HG = mercury	NSR = not separately replaceable	S-B = slow-blow
B. F. O. = beat frequency oscillator	HR = hour(s)	OBD = order by description	SCR = screw
BE CU = beryllium copper	IF = intermediate freq	OH = oval head	SE = selenium
BH = binder head	IMPG = impregnated	OX = oxide	SECT = section(s)
BP = bandpass	INCD = incandescent	PH BRZ = phosphor bronze	SEMICON = semiconductor
BRS = brass	INCL = include(s)	PHL = Phillips	SI = silicon
BWO = backward wave oscillator	INS = insulation(ed)	PIV = peak inverse voltage	SIL = silver
CCW = counter-clockwise	INT = internal	PNP = positive-negative-positive	SL = slide
CER = ceramic	K = kilo = 1000	P/O = part of	SPG = spring
CMO = cabinet mount only	LH = left hand	POLY = polystyrene	SPL = special
COEF = coefficient	LIN = linear taper	PORC = porcelain	SST = stainless steel
COM = common	LK WASH = lock washer	POS = position(s)	SR = split ring
COMP = composition	LOG = logarithmic taper	POT = potentiometer	STL = steel
COMPL = complete	LPF = low pass filter	PP = peak-to-peak	TA = tantalum
CONN = connector	M = milli = 10 ⁻³	PT = point	TD = time delay
CP = cadmium plate	MET OX = metallic oxide	PWV = peak working voltage	TGL = toggle
CRT = cathode-ray tube	MFR = manufacturer	RECT = rectifier	THD = thread
CW = clockwise	MINAT = miniature	RF = radio frequency	TI = titanium
DEPC = deposited carbon	MOM = momentary	RH = round head or right hand	TOL = tolerance
DR = drive	MTG = mounting	RMO = rack mount only	TRIM = trimmer
ELECT = electrolytic	MY = "mylar"		TWT = travelling wave tube
ENCAP = encapsulated	N = nano (10 ⁻⁹)		U = micro = 10 ⁻⁶
EXT = external	N/C = normally closed		VAR = variable
F = farads	NE = neon		VDCW = dc working volts
FH = flat head	NI PL = nickel plate		W/ = with
FIL H = fillister head	N/O = normally open		W = watts
FXD = fixed	NPO = negative positive zero (zero temperature coefficient)		WIV = working inverse voltage
GE = germanium			WW = wirewound
GL = glass			W/O = without
GRD = ground(ed)			

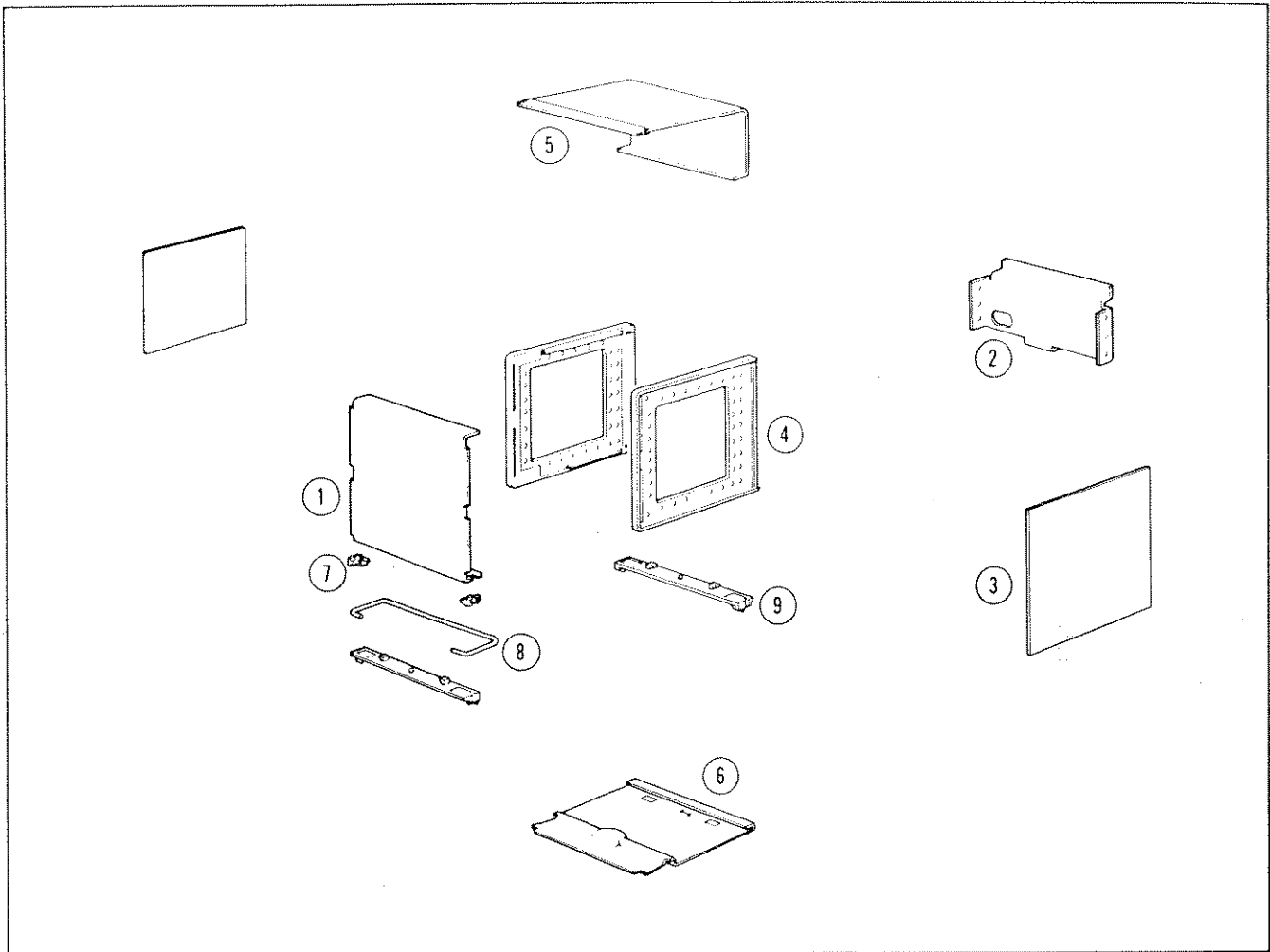

ITEM NO.	DESCRIPTION	HP STOCK NO.	QTY
1	Front Panel	04260-1240	1
2	Rear Panel W/deck	04260-7025	1
3	Side Cover	5000-8565	2
4	Side Frame	5060-0703	2
5	Top Cover	5060-8573	1
6	Bottom Cover	5000-8583	1
7	Hinge	5040-0700	2
8	Tilt Stand	1490-0032	1
9	Foot Assembly	5060-0728	2

Figure 6-1. Modular Cabinet Parts

Table 6-1. Reference Designation Index

Reference Designation	Stock No.	Description #	Note
A100	04260-7055	ASSY:RANGE AND FUNCTION SWITCH	
C101	0160-1551	C:FXD MY 0.18 UF 10% 100VDCW FACTORY SELECTED PART;TYPICAL VALUE GIVEN	*
C102	0160-1161	C:FXD PAPER 2000 PF 10% 600VDCW FACTORY SELECTED PART;TYPICAL VALUE GIVEN	
C103	0121-0039	C:VAR CER 8-50PF 350VDCW FACTORY SELECTED PART;TYPICAL VALUE GIVEN	
C104	0121-0039	C:VAR CER 8-50PF 350VDCW	
C105	0160-1045	C:FXD CER 4 PF/0.25 PF 500VDCW FACTORY SELECTED PART;TYPICAL VALUE GIVEN	
R101	04260-8604	R:FXD WW 0.986 OHM 0.3% FACTORY SELECTED PART;TYPICAL VALUE GIVEN	
R102	04255-8604	R:FXD WW 10 OHM 0.1%	
R103	0698-1381	R:FXD MET FLM 100 OHM 0.1% 1/2W	
R104	0698-1380	R:FXD MET FLM 1K OHM 0.1% 1/2W	
R105	0698-1268	R:FXD MET FLM 10K OHM 0.1% 1/2W	
R106	0698-1376	R:FXD MET FLM 97K OHM 0.1% 1/4W	
R107	0698-1375	R:FXD MET FLM 3K OHM 1% 1/4W	
R108	0698-1377	R:FXD MET FLM 970K OHM 0.1% 1/4W	
R109	0698-1374	R:FXD MET FLM 30K OHM 1% 1/4W	
R110	0698-1400	R:FXD MET FLM 500 OHM 0.1% 1/2W	
R111	0698-4142	R:FXD MET FLM 15.8 OHM 1% 1/4W	
S101	04260-7056	SWITCH:ROTARY FOR RANGE,FUNCTION PART OF S101	
S102			
A200	04260-7022	ASSY:POWER SUPPLY AND 1KHZ OSC	
C201	0180-0967	C:FXD ELECT 500 UF 25VDCW	
C202	0180-0756	C:FXD ELECT 20 UF 15VDCW	
C203	0180-0756	C:FXD ELECT 20 UF 15VDCW	
C204	0180-0965	C:FXD ELECT 200 UF 25VDCW	
C205	0180-0756	C:FXD ELECT 20 UF 15VDCW	
C206	0180-0964	C:FXD ELECT 100 UF 50VDCW	
C207	0180-0981	C:FXD ELECT 22 UF 160VDCW	
C208	0180-1029	C:FXD TANT 1 UF 20% 15VDCW	
C209	0160-1610	C:FXD MY 4700 PF 5% 100VDCW	
C210	0160-1610	C:FXD MY 4700 PF 5% 100VDCW	
C211	0180-1026	C:FXD TANT 47 UF 20% 6VDCW	
C212	0180-1029	C:FXD TANT 1 UF 20% 15VDCW	
C213	0180-0756	C:FXD ELECT 20 UF 15VDCW	
C214	0180-0756	C:FXD ELECT 20 UF 15VDCW	
CR201	1901-0045	SEMICON DEVICE:DIODE SILICON	
CR202	1901-0045	SEMICON DEVICE:DIODE SILICON	
CR203	1902-0031	DIODE:BREAKDOWN 12.7V 5% 400 MW	
CR204	1901-0045	SEMICON DEVICE:DIODE SILICON	
CR205	1902-0031	DIODE:BREAKDOWN 12.7V 5% 400 MW	
CR206	1901-0028	DIODE:SILICON 400 PIV 0.5 AMP	
CR207	1901-0028	DIODE:SILICON 400 PIV 0.5 AMP	
Q201	1854-0003 1205-0033	TRANSISTOR:PNP SILICON HEAT DISSIPATOR FOR Q201	

See list of abbreviations in introduction to this section

Table 6-1, Reference Designation Index (Cont'd)

Reference Designation	Stock No.	Description #	Note
Q202	1854-0071	TRANSISTOR SILICON NPN 2N3391	
Q203	1854-0071	TRANSISTOR SILICON NPN 2N3391	
Q204	1854-0071	TRANSISTOR SILICON NPN 2N3391	
Q205	1854-0071	TRANSISTOR SILICON NPN 2N3391	
Q206	1854-0071	TRANSISTOR SILICON NPN 2N3391	
Q207	1854-0071	TRANSISTOR SILICON NPN 2N3391	
R201	0684-2721	RIFXD COMP 2700 OHM 10% 1/4W	
R202	0684-2721	RIFXD COMP 2700 OHM 10% 1/4W	
R203	0684-6821	RIFXD COMP 6800 OHM 10% 1/4W	
R204	0683-6815	RIFXD COMP 680 OHM 5% 1/4W	
R205	0684-4721	RIFXD COMP 4700 OHM 10% 1/4W	
R206	0684-2231	RIFXD COMP 22K OHM 10% 1/4W	
R207	0690-1821	RIFXD COMP 1800 OHM 10% 1W	
R208	0757-0960	RIFXD MET FLM 33K OHM 2% 1/8W	
R209	0757-0959	RIFXD MET FLM 30K OHM 2% 1/8W	
R210	2100-1761	RIVAR WW 10K OHM 10% LIN 1/2W	
R211	0757-0941	RIFXD MET FLM 5.1K OHM 2% 1/8W	
R212	0757-0926	RIFXD MET FLM 1.2K OHM 2% 1/8W	
R213	2100-1762	RIVAR WW 10K OHM 10% LIN 1/2W	
R214	0684-2741	RIFXD COMP 270K OHM 10% 1/4W	
R215	0757-0930	RIFXD MET FLM 1.8K OHM 2% 1/8W	
R216	0684-6831	RIFXD COMP 68K OHM 10% 1/4W	
R217	0683-2025	RIFXD COMP 2000 OHM 5% 1/4W	
R218	0683-5635	RIFXD COMP 56K OHM 5% 1/4W	
R219	0683-1235	RIFXD COMP 12K OHM 5% 1/4W	
R220	0683-8215	RIFXD COMP 820 OHM 5% 1/4W	
A300	04260-7023	ASSY REFERENCE VOLTAGE	
C301	0180-0962	CIFXD TANT 1 UF 20% 35VDCW	
C302	0180-0773	CIFXD ELECT 50 UF 15VDCW	
C303	0180-1026	CIFXD TANT 47 UF 20% 6VDCW	
C304	0160-1271	CIFXD MY 0.01 UF 5% 50VDCW	
C305	0160-2306	CIFXD MICA 27 PF ±10% 500VDCW	*
		FACTORY SELECTED PART; TYPICAL VALUE GIVEN	
C306	0180-1026	CIFXD TANT 47 UF 20% 6VDCW	
C307	0180-0978	CIFXD TANT 1 UF +75-15% 50VDCW	
C308	0180-0773	CIFXD ELECT 50 UF 15VDCW	
C309	0180-1029	CIFXD TANT 1 UF 20% 15VDCW	
C310	0180-1029	CIFXD TANT 1 UF 20% 15VDCW	
C311	0180-0945	CIFXD ELECT 50 UF 6VDCW	
C312	0180-1029	CIFXD TANT 1 UF 20% 15VDCW	
C313	0180-1029	CIFXD TANT 1 UF 20% 15VDCW	
C314	0180-0945	CIFXD ELECT 50 UF 6VDCW	
C315	0180-1029	CIFXD TANT 1 UF 20% 15VDCW	
C316	0180-1029	CIFXD TANT 1 UF 20% 15VDCW	
C317	0180-1029	CIFXD TANT 1 UF 20% 15VDCW	
C318	0160-1543	CIFXD MY 2200 PF 5% 50VDCW	
C319	0180-0945	CIFXD ELECT 50 UF 6VDCW	
CR301	1901-0040	DIODE SILICON 30 MA AT 1V 30 PIV	
CR302	1901-0040	DIODE SILICON 30 MA AT 1V 30 PIV	

See list of abbreviations in introduction to this section

Table 6-1. Reference Designation Index (Cont'd)

Reference Designation	Stock No.	Description #	Note
CR303	1901-0040	DIODE:SILICON 30 MA AT 1V 30 PIV	
CR304	1901-0040	DIODE:SILICON 30 MA AT 1V 30 PIV	
CR305	1901-0040	DIODE:SILICON 30 MA AT 1V 30 PIV	
CR306	1901-0040	DIODE:SILICON 30 MA AT 1V 30 PIV	
CR307	1910-0016	DIODE:GERMANIUM 100MA AT 0.85V 60PIV	
CR308	1910-0016	DIODE:GERMANIUM 100MA AT 0.85V 60PIV	
Q301	1854-0071	TRANSISTOR:SILICON NPN 2N3391	
Q302	1853-0010	TRANSISTOR:SILICON PNP	
Q303	1854-0071	TRANSISTOR:SILICON NPN 2N3391	
Q304	1854-0071	TRANSISTOR:SILICON NPN 2N3391	
Q305	1853-0010	TRANSISTOR:SILICON PNP	
Q306	1854-0071	TRANSISTOR:SILICON NPN 2N3391	
Q307	1854-0071	TRANSISTOR:SILICON NPN 2N3391	
Q308	1854-0071	TRANSISTOR:SILICON NPN 2N3391	
Q309	1854-0071	TRANSISTOR:SILICON NPN 2N3391	
Q310	1854-0071	TRANSISTOR:SILICON NPN 2N3391	
Q311	1854-0071	TRANSISTOR:SILICON NPN 2N3391	
Q312	1854-0071	TRANSISTOR:SILICON NPN 2N3391	
Q313	1854-0071	TRANSISTOR:SILICON NPN 2N3391	
R301	0684-1231	R:FXD COMP 12K OHM 10% 1/4W	
R302	0683-7515	R:FXD COMP 750 OHM 5% 1/4W	
R303	0757-0968	R:FXD MET FLM 68K OHM 2% 1/8W	
R304	0684-4731	R:FXD COMP 47K OHM 10% 1/4W	
R305	0757-0951	R:FXD MET FLM 13K OHM 2% 1/8W	
R306	0683-5625	R:FXD COMP 5600 OHM 5% 1/4W	
R307	0683-1225	R:FXD COMP 1200 OHM 5% 1/4W	
R308	0683-5625	R:FXD COMP 5600 OHM 5% 1/4W	
R309	0683-2035	R:FXD COMP 20K OHM 5% 1/4W	
R310	0757-0928	R:FXD MET FLM 1.5K OHM 2% 1/8W	
R311	0757-0928	R:FXD MET FLM 1.5K OHM 2% 1/8W	
R312	0683-5135	R:FXD COMP 51K OHM 5% 1/4W	
R313	0757-0926	R:FXD MET FLM 1.2K OHM 2% 1/8W	
R314	0683-5625	R:FXD COMP 5600 OHM 5% 1/4W	
R315	0757-0926	R:FXD MET FLM 1.2K OHM 2% 1/8W	
R316	0684-4731	R:FXD COMP 47K OHM 10% 1/4W	
R317	0757-0951	R:FXD MET FLM 13K OHM 2% 1/8W	
R318	0683-7515	R:FXD COMP 750 OHM 5% 1/4W	
R319	0757-0968	R:FXD MET FLM 68K OHM 2% 1/8W	
R320	0684-1231	R:FXD COMP 12K OHM 10% 1/4W	
R321	0684-2231	R:FXD COMP 22K OHM 10% 1/4W	
R322	0684-6821	R:FXD COMP 6800 OHM 10% 1/4W	
R323	0684-6821	R:FXD COMP 6800 OHM 10% 1/4W	
R324	0684-2721	R:FXD COMP 2700 OHM 10% 1/4W	
R325	0684-8221	R:FXD COMP 8200 OHM 10% 1/4W	
R326	0684-1031	R:FXD COMP 10K OHM 10% 1/4W	
R327	0684-1521	R:FXD COMP 1500 OHM 10% 1/4W	
R328	0684-2741	R:FXD COMP 270K OHM 10% 1/4W	
R329	0684-6821	R:FXD COMP 6800 OHM 10% 1/4W	
R330	0684-2721	R:FXD COMP 2700 OHM 10% 1/4W	
R331	0684-5621	R:FXD COMP 5.6K OHM 10% 1/4W	

See list of abbreviations in introduction to this section

Table 6-1. Reference Designation Index (Cont'd)

Reference Designation	Stock No.	Description #	Note
R332	0683-1225	R:FXD COMP 1200 OHM 5% 1/4W	
R333	0684-4721	R:FXD COMP 4700 OHM 10% 1/4W	
R334	0683-5625	R:FXD COMP 5600 OHM 5% 1/4W	
R335	0683-8225	R:FXD COMP 8200 OHM 5% 1/4W	
R336	0683-6825	R:FXD COMP 6800 OHM 5% 1/4W	
R337	0684-4721	R:FXD COMP 4700 OHM 10% 1/4W	
R338	0683-3025	R:FXD COMP 3000 OHM 5% 1/4W	
R339	0683-3625	R:FXD COMP 3600 OHM 5% 1/4W	
R340	0683-2425	R:FXD COMP 2400 OHM 5% 1/4W	
R341	0683-1335	R:FXD COMP 13K OHM 5% 1/4W	
R342	0683-1235	R:FXD COMP 12K OHM 5% 1/4W	
R343	0683-3015	R:FXD COMP 300 OHM 5% 1/4W	
R344	0683-5635	R:FXD COMP 56K OHM 5% 1/4W	
R345	0684-4721	R:FXD COMP 4700 OHM 10% 1/4W	
A400	04260-7724	ASSY:DETECTOR	
C401	0180-0708	C:FXD ELECT 3 UF 15VDCW	
C402	0160-1271	C:FXD MY 0.01 UF 5% 50VDCW	
C403	0160-1542	C:FXD MY 1500 PF 10% 50VDCW	
C404	0180-1032	C:FXD TANT 10 UF 20% 15VDCW	
C405	0160-1271	C:FXD MY 0.01 UF 5% 50VDCW	
C406	0160-1545	C:FXD MY 0.022 UF 5% 50VDCW	
C407	0160-1271	C:FXD MY 0.01 UF 5% 50VDCW	
C408	0180-1029	C:FXD TANT 1 UF 20% 15VDCW	
C409	0180-0756	C:FXD ELECT 20 UF 15VDCW	
C410	0180-0756	C:FXD ELECT 20 UF 15VDCW	
C411	0180-0756	C:FXD ELECT 20 UF 15VDCW	
C412	0160-1271	C:FXD MY 0.01 UF 5% 50VDCW	
C413	0180-0756	C:FXD ELECT 20 UF 15VDCW	
C414	0180-0756	C:FXD ELECT 20 UF 15VDCW	
C415	0180-0756	C:FXD ELECT 20 UF 15VDCW	
C416	0140-0204	C:FXD MICA 47PF 5% NPO 500VDCW	
C417	0140-0194	C:FXD MICA 110 PF 5% 300 VDCW	
C418	0160-1544	C:FXD MY 4700 PF 5% 50VDCW	
C419	0180-0945	C:FXD ELECT 50 UF 6VDCW	
C420	0180-1032	C:FXD TANT 10 UF 20% 15VDCW	
C421	0180-0966	C:FXD TANT 220 μ F 10% 10VDCW	
C422	0180-1025	C:FXD TANT 22 μ F 20% 6VDCW	
C423	0160-1038	C:FXD CER 20 pF 10% 500VDCW	
C424	0160-0168	C:FXD MYLAR 0.1 μ F 10%	
CR401	1902-0037	SEMICON DEVICE:DIODE	
CR402	1901-0040	DIODE:SILICON 30 MA AT 1V 30 PIV	
CR403	1901-0040	DIODE:SILICON 30 MA AT 1V 30 PIV	
CR404	1901-0040	DIODE:SILICON 30 MA AT 1V 30 PIV	
CR405	1901-0040	DIODE:SILICON 30 MA AT 1V 30 PIV	
CR406	1910-0016	DIODE:GERMANIUM 100MA AT 0.85V 60PIV	
CR407	1910-0016	DIODE:GERMANIUM 100MA AT 0.85V 60PIV	
CR408	1910-0016	DIODE:GERMANIUM 100MA AT 0.85V 60PIV	
CR409	1910-0016	DIODE:GERMANIUM 100MA AT 0.85V 60PIV	
CR410	1910-0016	DIODE:GERMANIUM 100MA AT 0.85V 60PIV	
CR411	1910-0016	DIODE:GERMANIUM 100MA AT 0.85V 60PIV	
CR412	1910-0016	DIODE:GERMANIUM 100MA AT 0.85V 60PIV	

See list of abbreviations in introduction to this section

Table 6-1. Reference Designation Index (Cont'd)

Reference Designation	Stock No.	Description #	Note
CR413	1910-0016	DIODE:GERMANIUM 100 MA AT 0.85V 50 PIV	
CR414	1910-0016	DIODE:GERMANIUM 100 MA AT 0.85V 50 PIV	
CR415	1910-0016	DIODE:GERMANIUM 100 MA AT 0.85V 50 PIV	
CR416	1901-0040	DIODE:SILICON 30 MA AT 1V 30 PIV	
CR417	1901-0040	DIODE:SILICON 30 MA AT 1V 30 PIV	
CR418	1901-0040	DIODE:SILICON 30 MA AT 1V 30 PIV	
CR419	1901-0040	DIODE:SILICON 30 MA AT 1V 30 PIV	
CR420	1901-0040	DIODE:SILICON 30 MA AT 1V 30 PIV	
CR421	1902-0057	SEMICON DEVICE:DIODE SILICON	
CR422	1901-0040	DIODE:SILICON 30 MA AT 1V 30 PIV	
CR423	1901-0040	DIODE:SILICON 30 MA AT 1V 30 PIV	
L401	9100-0729	INDUCTOR:FXD 100 UH 10%	
Q401	5080-3016	TRANSISTOR:SILICON NPN 2N3391, SELECTED	
Q402	1853-0010	TRANSISTOR:SILICON PNP	
Q403	1854-0071	TRANSISTOR:SILICON NPN 2N3391	
Q404	1854-0071	TRANSISTOR:SILICON NPN 2N3391	
Q405	1854-0071	TRANSISTOR:SILICON NPN 2N3391	
Q406	1854-0071	TRANSISTOR:SILICON NPN 2N3391	
Q407	1854-0071	TRANSISTOR:SILICON NPN 2N3391	
Q408	1854-0071	TRANSISTOR:SILICON NPN 2N3391	
Q409	1854-0071	TRANSISTOR:SILICON NPN 2N3391	
Q410	1854-0071	TRANSISTOR:SILICON NPN 2N3391	
Q411	1854-0071	TRANSISTOR:SILICON NPN 2N3391	
Q412	1854-0071	TRANSISTOR:SILICON NPN 2N3391	
Q413	1854-0071	TRANSISTOR:SILICON NPN 2N3391	
Q414	1854-0071	TRANSISTOR:SILICON NPN 2N3391	
Q415	1854-0003	TRANSISTOR:PNP SILICON	
Q416	1854-0071	TRANSISTOR:SILICON NPN 2N3391	
Q417	1854-0071	TRANSISTOR:SILICON NPN 2N3391	
Q418	1854-0022	TRANSISTOR:PNP SILICON	
R401	0683-1855	R:FXD COMP 1.8 MEGOHM 5% 1/4W	
R402	0683-2735	R:FXD COMP 27K OHM 5% 1/4W	
R403	0683-1235	R:FXD COMP 12K OHM 5% 1/4W	
R404	0683-4715	R:FXD COMP 470 OHM 5% 1/4W	
R405	0684-2231	R:FXD COMP 22K OHM 10% 1/4W	
R406	0684-1041	R:FXD COMP 100K OHM 10% 1/4W	
R407	0684-8221	R:FXD COMP 8200 OHM 10% 1/4W	
R408	0684-1531	R:FXD COMP 15K OHM 10% 1/4W	
R409	0683-1045	R:FXD COMP 100K OHM 5% 1/4W	
R410	0683-3045	R:FXD COMP 300K OHM 5% 1/4W	
R411	0684-1031	R:FXD COMP 10K OHM 10% 1/4W	
R412	0684-8221	R:FXD COMP 8200 OHM 10% 1/4W	
R413	0757-0952	R:FXD MET FLM 15K OHM 2% 1/8W	
R414	0757-0955	R:FXD MET FLM 20K OHM 2% 1/8W	
R415	0683-5635	R:FXD COMP 56K OHM 5% 1/4W FACTORY SELECTED PART; TYPICAL VALUE GIVEN	
R416	0757-0947	R:FXD MET FLM 9.1K OHM 2% 1/8W	
R417	0683-1045	R:FXD COMP 100K OHM 5% 1/4W FACTORY SELECTED PART; TYPICAL VALUE GIVEN	
R418	0683-2715	R:FXD COMP 270 OHM 5% 1/4W	
R419	0683-3315	R:FXD COMP 330 OHM 5% 1/4W	

See list of abbreviations in introduction to this section

Table 6-1. Reference Designation Index (Cont'd)

Reference Designation	Stock No.	Description #	Note
R420	0757-0953	R:FXD MET FLM 16K OHM 2% 1/8W	
R421	0683-1225	R:FXD COMP 1200 OHM 5% 1/4W	
R422	0683-1225	R:FXD COMP 1200 OHM 5% 1/4W	
R423	0684-2721	R:FXD COMP 2700 OHM 10% 1/4W	
R424	0684-2741	R:FXD COMP 270K OHM 10% 1/4W	
R425	0684-1041	R:FXD COMP 100K OHM 10% 1/4W	
R426	0757-0947	R:FXD MET FLM 9.1K OHM 2% 1/8W	
R427	0757-0947	R:FXD MET FLM 9.1K OHM 2% 1/8W	
R428	0683-3645	R:FXD COMP 360K OHM 5% 1/4W	
R429	0683-2745	R:FXD COMP 270K OHM 5% 1/4W	
R430	0757-0935	R:FXD MET FLM 3.0K OHM 2% 1/8W	
R431	0757-0935	R:FXD MET FLM 3.0K OHM 2% 1/8W	
R432	0684-1521	R:FXD COMP 1500 OHM 10% 1/4W	
R433	0757-0960	R:FXD MET FLM 33K OHM 2% 1/8W	
R434	0757-0960	R:FXD MET FLM 33K OHM 2% 1/8W	
R435	0757-0939	R:FXD MET FLM 4.3K OHM 2% 1/8W	
R436	0757-0939	R:FXD MET FLM 4.3K OHM 2% 1/8W	
R437	0684-1521	R:FXD COMP 1500 OHM 10% 1/4W	
R438	0757-0960	R:FXD MET FLM 33K OHM 2% 1/8W	
R439	0757-0960	R:FXD MET FLM 33K OHM 2% 1/8W	
R440	0757-0939	R:FXD MET FLM 4.3K OHM 2% 1/8W	
R441	0757-0939	R:FXD MET FLM 4.3K OHM 2% 1/8W	
R442	0684-1041	R:FXD COMP 100K OHM 10% 1/4W	*
R443	0683-6835	R:FXD COMP 68K OHM 5% 1/4W	
R444	0684-6821	R:FXD COMP 6800 OHM 10% 1/4W	
R445	0684-1041	R:FXD COMP 100K OHM 10% 1/4W	
R446	0683-6215	R:FXD COMP 620 OHM 5% 1/4W	
R447	0683-6215	R:FXD COMP 620 OHM 5% 1/4W	
R448	0683-6215	R:FXD COMP 620 OHM 5% 1/4W	
R449	0683-6815	R:FXD COMP 680 OHM 5% 1/4W	
R450	0683-1215	R:FXD COMP 120 OHM 5% 1/4W	
R451	0684-2721	R:FXD COMP 2700 OHM 10% 1/4W	
R452	0684-1041	R:FXD COMP 100K OHM 10% 1/4W	*
R453	0683-6835	R:FXD COMP 68K OHM 5% 1/4W	
R454	0683-5625	R:FXD COMP 5600 OHM 5% 1/4W	
R455	0683-2225	R:FXD COMP 2.2K OHM 5% 1/4W FACTORY SELECTED PART,TYPICAL VALUE GIVEN	
R456	0683-2445	R:FXD COMP 240K OHM 5% 1/4W	
R457	0683-1845	R:FXD COMP 180K OHM 5% 1/4W	
R458	0698-0060	R:FXD COMP 3.6M OHM 5% 1/4W	
R459	0684-2721	R:FXD COMP 2.7K OHM 10% 1/4W	
A500	04260-7053	CHASSIS ASSY'INCL:S2'J1-J4 115/230V ONLY	
* FACTORY SELECTED PART, TYPICAL VALUE GIVEN			

See list of abbreviations in introduction to this section

Table 6-1. Reference Designation Index (Cont'd)

Reference Designation	Stock No.	Description #	Note
A600	04260-7026	ASSY:DECIMAL POINT AND DIRECTION IND	
R60I	0687-8231	R:FXD COMP 82K OHM 10% 1/2W	
V60I	2140-0127	LAMP:GLOW 1/10W	
V602	2140-0127	LAMP:GLOW 1/10W	
V603	2140-0018	LAMP:GLOW 1/10W	
V604	2140-0018	LAMP:GLOW 1/10W	
V605	2140-0018	LAMP:GLOW 1/10W	
C1	0160-1540	C:FXD MICA 0.2 UF 0.2%	
C2	0160-1515	C:FXD MICA 2200 PF 10% 500VDCW FACTORY SELECTED PART;TYPICAL VALUE GIVEN	
C3	0121-0205	C:VAR CER 5 PF 250VDCW	
C4	0160-1031	C:FXD CER 10 PF 10% 500VDCW FACTORY SELECTED PART;TYPICAL VALUE GIVEN	
C5	0160-1510	C:FXD MICA 1200 PF 10% 500VDCW	
C6	0160-1227	C:FXD METAL PAPER .05 UF 10% 250VDCW	*
CR1	1910-0016	DIODE:GERMANIUM 100MA AT 0.85V 60PIV	
CR2	1910-0016	DIODE:GERMANIUM 100MA AT 0.85V 60PIV	*
F1	2110-0234 2110-0311	FUSE: CARTRIDGE SLO-BLO 0.1A FOR 115V OPERATION FUSE: CARTRIDGE SLO-BLO 62mA FOR 230V OPERATION	
J1	1251-0148	CONNECTOR:POWER 3 PIN MALE	
J2	1251-0141	CONNECTOR:18-CONTACT	
J3	1251-0135	CONNECTOR:PRINTED CIRCUIT 15 CONTACTS	
J4	1251-0135	CONNECTOR:PRINTED CIRCUIT 15 CONTACTS	
J5		CONNECTOR:INCLUDES:	
J6	1510-0011 04260-5021 04260-5022 04260-5028	BINDING POST:BLACK(2 USED) INSULATOR:2 EACH INSULATOR:2 EACH CONNECTOR:FOR BIAS BATTERY	
J7	04260-1049 04260-5028	SHORTING BAR FOR J6 CONNECTOR:FOR EXT RESISTOR CP,LS AND BIAS CAPACITOR	
J8	04260-1049 04260-5028	SHORTING BAR FOR J7 CONNECTOR:FOR EXT RESISTOR,CS,LP	
J9	04260-1049	SHORTING BAR FOR J8	
J10	04260-5028 04260-5028	CONNECTOR:FOR EXT OSCILLATOR CONNECTOR:FOR DETECTOR	
M1	1120-0768	METER:50 μ A	
R1	2100-1172	R:VAR DEPC 5K OHM 10% 0.3W	
R2	0684-1521	R:FXD COMP 1500 OHM 10% 1/4W	
R3	04260-7040	R:VAR WW 5K OHM	
R4	2100-1171	R:VAR WW 10/4 OHM 10% 1.2W	
R5	04260-7031	R:VAR WW 16K OHM +100 OHM REPLACE ONLY WITH DQ DIAL	
		* FACTORY SELECTED PART;TYPICAL VALUE GIVEN	

= See list of abbreviations in introduction to this section

Table 6-1. Reference Designation Index (Cont'd)

Reference Designation	Stock No.	Description #	Note
R6	0698-1373	R:FXD DEPC 1 OHM 5% 1/2W	
R7	0684-1041	R:FXD COMP 100K OHM 10% 1/4W	
S1	3101-0206	SWITCH:SLIDE(LINE ON)	
S2	3101-0033	SWITCH:SLIDE DPCT(115/230V)	
S3	3101-0244	SWITCH:SLIDE(INT-EXT OSC)	
T1	04260-8602	TRANSFORMER:POWER	
T2	04260-8603	TRANSFORMER:OSC	
W1	8120-1371	CABLE ASSY:POWER CORD	
XF1	1400-0084	HOLDER:FUSE POST TYPE 3AG	
		MISCELLANEOUS	
	04260-1066	BRACKET	
	04260-1071	BRACKET:COUNTER	
	1410-0033	BUSHING FOR CRL CONTROL	
	04260-8542	CABLE:DIAL	
	1140-0030	COUNTER:CRL	
	04260-7027	GEAR ASSY:CRL COUNTER DRIVE	
	04260-5030	INDEX	
	0370-0050	KNOB FOR CRL CONTROL	
	0370-0275	KNOB FOR CRL CONTROL	
	0370-0272	KNOB:DQ CONTROL	
	0370-0267	KNOB:DQ VERNIER	
	0370-0077	KNOB:FUNCTION	
	0370-0077	KNOB:RANGE	
	0370-0256	KNOB:SENSITIVITY	
	04260-5024	LENS:FINGER	
	04260-5059	PULLEY FOR R5	
	04260-5027	WINDOW GLASS	
	04260-7057	SCALE DRUM ASS'Y	
	04260-1082	BRACKET:METER	
		ITEMS BELOW FOR 100 VAC OR 200 VAC ONLY	
	1251-0048	ADAPTER:PLUG (100/200V ONLY)	
	04260-7032	CHASSIS ASSY:INCL S2,J1-J4	
	04260-1038	FRONT PANEL	
	7120-0492	NAMEPLATE:100/200V	
	7120-0495	NAMEPLATE:100V ONLY	
	04260-9990	OPERATING AND SERVICE MANUAL (100/200 VAC ONLY)	
	04260-99003	OPERATING AND SERVICE MANUAL (115/230 VAC ONLY)	

See list of abbreviations in introduction to this section

Table 6-2. Replaceable Parts

Stock No.	Description #	Mfr.	Mfr. Part No.	TQ
0121-0039	C:VAR CER 8-50PF 350VDCW	28480	0121-0039	2
0121-0205	C:VAR CER 5 PF 250VDCW	28480	0121-0205	1
0140-0194	C:FXD MICA 110 PF 5% 300 VDCW	04062	RDM15F111J3C	1
0140-0204	C:FXD MICA 47PF 5% NPO 500VDCW	04062	RDM15E470J5C	1
0160-1031	C:FXD CER 10 PF 10% 500VDCW	28480	0160-1031	1
0160-1038	C:FXD CER 20pF 10% 500VDCW	28480	0160-1038	
0160-1039	C:FXD CER 25 PF 10% 500VDCW	28480	0160-1039	1
0160-1045	C:FXD CER 4 PF/0.25 PF 500VDCW	28480	0160-1045	1
0160-1161	C:FXD PAPER 2000 PF 10% 600VDCW	28480	0160-1161	1
0160-1227	C:FXD METAL PAPER .05 UF 10% 250VDCW	28480	0160-1227	1
0160-1271	C:FXD MY 0.01 UF 5% 50VDCW	28480	0160-1271	
0160-1510	C:FXD MICA 1200 PF 10% 500VDCW	28480	0160-1510	1
0160-1515	C:FXD MICA 2200 PF 10% 500VDCW	28480	0160-1515	1
0160-1540	C:FXD MICA 0.2 UF 0.2%	28480	0160-1540	1
0160-1542	C:FXD MY 1500 PF 10% 50VDCW	28480	0160-1542	1
0160-1543	C:FXD MY 2200 PF 5% 50VDCW	28480	0160-1543	1
0160-1544	C:FXD MY 4700 PF 5% 50VDCW	28480	0160-1544	3
0160-1545	C:FXD MY 0.022 UF 5% 50VDCW	28480	0160-1545	1
0160-1548	C:FXD MY 0.22 UF 10% 100VDCW	28480	0160-1548	1
0180-0708	C:FXD ELECT 3 UF 15VDCW	28480	0180-0708	1
0180-0756	C:FXD ELECT 20 UF 15VDCW	28480	0180-0756	11
0180-0773	C:FXD ELECT 50 UF 15VDCW	28480	0180-0773	2
0180-0945	C:FXD ELECT 50 UF 6VDCW	28480	0180-0945	4
0180-0962	C:FXD TANT 1 UF 20% 35VDCW	28480	0180-0962	1
0180-0964	C:FXD ELECT 100 UF 50VDCW	28480	0180-0964	1
0180-0965	C:FXD ELECT 200 UF 25VDCW	28480	0180-0965	1
0180-0966	C:FXD TANT 220 UF 10% 10VDCW	28480	0180-0966	1
0180-0967	C:FXD ELECT 500 UF 25VDCW	28480	0180-0967	1
0180-0978	C:FXD TANT 1 UF +75-15% 50VDCW	28480	0180-0978	1
0180-0981	C:FXD ELECT 22 UF 160VDCW	28480	0180-0981	1
0180-1025	C:FXD TANT 22 UF 20% 6VDCW	28480	0180-1025	1
0180-1026	C:FXD TANT 47 UF 20% 6VDCW	28480	0180-1026	3
0180-1029	C:FXD TANT 1 UF 20% 15VDCW	28480	0180-1029	10
0180-1032	C:FXD TANT 10 UF 20% 15VDCW	28480	0180-1032	2
0370-0050	KNOB FOR CRL CONTROL	28480	0370-0050	1
0370-0077	KNOB:FUNCTION	28480	0370-0077	2
0370-0256	KNOB:SENSITIVITY	28480	0370-0256	1
0370-0267	KNOB:DQ VERNIER	28480	0370-0267	1
0370-0272	KNOB:DQ CONTROL	28480	0370-0272	1
0370-0275	KNOB FOR CRL CONTROL	28480	0370-0275	1
0683-1045	R:FXD COMP 100K OHM 5% 1/4W	01121	CB 1045	2
0683-1215	R:FXD COMP 120 OHM 5% 1/4W	01121	CB 1215	1
0683-1225	R:FXD COMP 1200 OHM 5% 1/4W	01121	CB 1225	4
0683-1235	R:FXD COMP 12K OHM 5% 1/4W	01121	CB 1235	3
0683-1335	R:FXD COMP 13K OHM 5% 1/4W	01121	CB 1335	1
0683-1845	R:FXD COMP 180K OHM 5% 1/4W	01121	CB 1845	1
0683-1855	R:FXD COMP 1.8 MEGOHM 5% 1/4W	01121	CB 1855	1
0683-2025	R:FXD COMP 2000 OHM 5% 1/4W	01121	CB 2025	1
0683-2035	R:FXD COMP 20K OHM 5% 1/4W	01121	CB 2035	1
0683-2225	R:FXD COMP 2.2K OHM 5% 1/4W	01121	GB 2225	1
0683-2425	R:FXD COMP 2400 OHM 5% 1/4W	01121	CB 2425	1
0683-2445	R:FXD COMP 240K OHM 5% 1/4W	01121	CB 2445	1

See list of abbreviations in introduction to this section

Table 6-2. Replaceable Parts (Cont'd)

Stock No.	Description #	Mfr.	Mfr. Part No.	TQ
0683-2715	R:FXD COMP 270 OHM 5% 1/4W	01121	CB 2715	1
0683-2735	R:FXD COMP 27K OHM 5% 1/4W	01121	CB 2735	1
0683-2745	R:FXD COMP 270K OHM 5% 1/4W	01121	CB 2745	1
0683-3015	R:FXD COMP 300 OHM 5% 1/4W	01121	CB 3015	1
0683-3025	R:FXD COMP 3000 OHM 5% 1/4W	01121	CB 3025	1
0683-3045	R:FXD COMP 300K OHM 5% 1/4W	01121	CB 3045	1
0683-3315	R:FXD COMP 330 OHM 5% 1/4W	01121	CB 3315	1
0683-3625	R:FXD COMP 3600 OHM 5% 1/4W	01121	CB 3625	1
0683-3645	R:FXD COMP 360K OHM 5% 1/4W	28480	0683-3645	1
0683-4715	R:FXD COMP 470 OHM 5% 1/4W	01121	CB 4715	1
0683-5135	R:FXD COMP 51K OHM 5% 1/4W	01121	CB 5135	1
0683-5625	R:FXD COMP 5600 OHM 5% 1/4W	01121	CB 5625	5
0683-5635	R:FXD COMP 56K OHM 5% 1/4W	01121	CB 5635	3
0683-6215	R:FXD COMP 620 OHM 5% 1/4W	01121	CB 6215	3
0683-6815	R:FXD COMP 680 OHM 5% 1/4W	01121	CB 6815	2
0683-6825	R:FXD COMP 6800 OHM 5% 1/4W	01121	CB 6825	1
0683-6835	R:FXD COMP 68K OHM 5% 1/4W	01121	CB 6835	2
0683-7515	R:FXD COMP 750 OHM 5% 1/4W	01121	CB 7515	2
0683-8215	R:FXD COMP 820 OHM 5% 1/4W	01121	CB 8215	1
0683-8225	R:FXD COMP 8200 OHM 5% 1/4W	01121	CB 8225	1
0683-8245	R:FXD COMP 820K OHM 5% 1/4W	01121	CB 8245	1
0684-1031	R:FXD COMP 10K OHM 10% 1/4W	01121	CB-1031	2
0684-1041	R:FXD COMP 100K OHM 10% 1/4W	01121	CB 1041	6
0684-1231	R:FXD COMP 12K OHM 10% 1/4W	28480	0684-1231	2
0684-1521	R:FXD COMP 1500 OHM 10% 1/4W	28480	0684-1521	4
0684-1531	R:FXD COMP 15K OHM 10% 1/4W	01121	CB 1531	1
0684-2231	R:FXD COMP 22K OHM 10% 1/4W	01121	CB 2231	3
0684-2721	R:FXD COMP 2700 OHM 10% 1/4W	01121	CB 2721	6
0684-2741	R:FXD COMP 270K OHM 10% 1/4W	01121	CB 2741	3
0684-4721	R:FXD COMP 4700 OHM 10% 1/4W	01121	CB 4721	4
0684-4731	R:FXD COMP 47K OHM 10% 1/4W	01121	CB 4731	2
0684-5621	R:FXD COMP 5.6K OHM 10% 1/4W	01121	CB 5621	1
0684-6821	R:FXD COMP 6800 OHM 10% 1/4W	01121	CB 6821	5
0684-6831	R:FXD COMP 68K OHM 10% 1/4W	28480	0684-6831	1
0684-8221	R:FXD COMP 8200 OHM 10% 1/4W	01121	CB 8221	3
0687-1541	R:FXD COMP 150K OHM 10% 1/2W	01121	EB 1541	1
0690-1821	R:FXD COMP 1800 OHM 10% 1W	01121	GB 1821	1
0698-1268	R:FXD MET FLM 10K OHM 0.1% 1/2W	28480	0698-1268	1
0698-1373	R:FXD DEPC 1 OHM 5% 1/2W	28480	0698-1373	1
0698-1374	R:FXD MET FLM 30K OHM 1% 1/4W	28480	0698-1374	1
0698-1375	R:FXD MET FLM 3K OHM 1% 1/4W	28480	0698-1375	1
0698-1376	R:FXD MET FLM 97K OHM 0.1% 1/4W	28480	0698-1376	1
0698-1377	R:FXD MET FLM 970K OHM 0.1% 1/4W	28480	0698-1377	1
0698-1380	R:FXD MET FLM 1K OHM 0.1% 1/2W	28480	0698-1380	1
0698-1381	R:FXD MET FLM 100 OHM 0.1% 1/2W	28480	0698-1381	1
0698-1400	R:FXD MET FLM 500 OHM 0.1% 1/2W	28480	0698-1400	1
0698-4142	R:FXD MET FLM 15.8 OHM 1% 1/4W	28480	0698-4142	1
0757-0926	R:FXD MET FLM 1.2K OHM 2% 1/8W	28480	0757-0926	3
0757-0928	R:FXD MET FLM 1.5K OHM 2% 1/8W	28480	0757-0928	2
0757-0930	R:FXD MET FLM 1.8K OHM 2% 1/8W	28480	0757-0930	1
0757-0935	R:FXD MET FLM 3.0K OHM 2% 1/8W	28480	0757-0935	2
0757-0939	R:FXD MET FLM 4.3K OHM 2% 1/8W	28480	0757-0939	4
0757-0941	R:FXD MET FLM 5.1K OHM 2% 1/8W	28480	0757-0941	1

See list of abbreviations in introduction to this section

Table 6-2. Replaceable Parts (Cont'd)

Stock No.	Description #	Mfr.	Mfr. Part No.	TQ
0757-0947	R:FXD MET FLM 9.1K OHM 2% 1/8W	28480	0757-0947	3
0757-0951	R:FXD MET FLM 13K OHM 2% 1/8W	28480	0757-0951	2
0757-0952	R:FXD MET FLM 15K OHM 2% 1/8W	28480	0757-0952	1
0757-0953	R:FXD MET FLM 16K OHM 2% 1/8W	28480	0757-0953	1
0757-0955	R:FXD MET FLM 20K OHM 2% 1/8W	28480	0757-0955	1
0757-0959	R:FXD MET FLM 30K OHM 2% 1/8W	28480	0757-0959	1
0757-0960	R:FXD MET FLM 33K OHM 2% 1/8W	28480	0757-0960	5
0757-0968	R:FXD MET FLM 68K OHM 2% 1/8W	28480	0757-0968	2
1120-0768	METER:50 UA	28480	1120-0768	1
1140-0030	COUNTER:CRL	28480	1140-0030	1
1205-0033	HEAT DISSIPATOR FOR Q201	28480	1205-0033	1
1251-0048	ADAPTER:PLUG (100/200V ONLY)	28480	1251-0048	1
1251-0135	CONNECTOR:PRINTED CIRCUIT 15 CONTACTS	95354	50-615UR	2
1251-0141	CONNECTOR:18-CONTACT	28480	1251-0141	1
1251-0148	CONNECTOR:POWER 3 PIN MALE	60427	H-1061-2	1
1400-0084	HOLDER:FUSE POST TYPE 3AG	75915	342014	1
1410-0033	BUSHING FOR CRL CONTROL	28480	1410-0033	1
1510-0011	BINDING POST:BLACK	28480	1510-0011	2
1853-0010	TRANSISTOR:SILICON PNP	28480	1853-0010	3
1854-0003	TRANSISTOR:NPN SILICON	28480	1854-0003	2
1854-0022	TRANSISTOR:NPN SILICON	28480	1854-0022	1
1854-0071	TRANSISTOR:SILICON NPN 2N3391	89473	16A792	31
1901-0028	DIODE:SILICON 400 PIV 0.5 AMP	28480	1901-0028	2
1901-0040	DIODE:SILICON 30 MA AT 1V 30 PIV	28480	1901-0040	15
1901-0045	SEMICON DEVICE:DIODE SILICON	28480	1901-0045	3
1902-0031	DIODE:BREAKDOWN 12.7V 5% 400 MW	28480	1902-0031	2
1902-0037	SEMICON DEVICE:DIODE	28480	1902-0037	1
1902-0057	SEMICON DEVICE:DIODE SILICON	28480	1902-0057	1
1910-0016	DIODE:GERMANIUM 100MA AT 0.85V 60PIV	28480	1910-0016	14
2100-1171	R:VAR WW 10/4 OHM 10% 1.2W	28480	2100-1171	1
2100-1172	R:VAR DEPC 5K OHM 10% 0.3W	28480	2100-1172	1
2100-1776	R:VAR WW 10K OHM 10% LIN 1/2W	28480	2100-1776	1
2100-1777	R:VAR WW 20K OHM 10% LIN 1/2W	28480	2100-1777	1
2110-0234	FUSE:CARTRIDGE SLC-BLO 100mAT 100V	28480	2100-0234	1
2110-0311	FUSE:CARTRIDGE SLC-BLO 62mAT 230V	28480	2100-0311	1
2140-0018	LAMP:GLOW 1/10W	24455	NE 2E1	5
3101-0033	SWITCH:SLIDE DPDT(115/230V)	79727	6510 C	1
3101-0889	SWITCH:SLIDE(LINE ON) PART OF 7056	28480	3101-0206	1
3101-0244	SWITCH:SLIDE(INT-EXT OSC)	28480	3101-0244	1
7120-0492	NAMEPLATE:100/200V	28480	7120-0492	1
8120-1378	CABLE ASSY:POWER CORD	28480	8120-1378	1
9100-0729	INDUCTOR:FXD 100 uH 10%	28480	9100-0729	1
5080-3016	TRANSISTOR:SILICON NPN 2N3391 SELECTED	28480	5080-3016	1
04255-8604	R:FXD WW 10 OHM 0.1%	28480	04255-8604	1
04260-1086	BRACKET	28480	04260-1086	1
04260-1138	FRONT PANEL(YHP)	28480	04260-1138	1
04260-1240	FRONT PANEL(HP)	28480	04260-1240	1
04260-1049	SHORTING BAR FOR J6	28480	04260-1049	3
04260-1071	BRACKET:COUNTER	28480	04260-1071	1

See list of abbreviations in introduction to this section

Table 6-2. Replaceable Parts (Cont'd)

Stock No.	Description #	Mfr.	Mfr. Part No.	TQ
04260-5021	INSULATOR:2 EACH	28480	04260-5021	2
04260-5022	INSULATOR:2 EACH	28480	04260-5022	2
04260-5028	CONNECTOR:FOR BIAS BATTERY	28480	04260-5028	5
04260-5024	LENS:FINDER	28480	04260-5024	1
04260-5027	WINDOW GLASS	28480	04260-5027	1
04260-5030	INDEX	28480	04260-5030	1
04260-5099	PULLEY FOR R5	28480	04260-5099	1
04260-7055	ASSY:RANGE,FUNCTION SWITCH & SCALE	28480	04260-7055	2
04260-7724	ASSY:DETECTOR	28480	04260-7724	1
04260-7053	CHASSIS ASSY:INCL S2:J1-J4	28480	04260-7053	1
04260-7026	ASSY:DECIMAL POINT AND DIRECTION IND	28480	04260-7026	1
04260-7040	R:VAR WW 5K OHM	28480	04260-7040	1
04260-7027	GEAR ASSY:CRL COUNTER DRIVE	28480	04260-7027	1
04260-7057	SCALE DRUM ASS'Y	28480	04260-7057	1
04260-7031	R:VAR WW 16K OHM +100 OHM	28480	04260-7031	1
04260-7032	CHASSIS ASSY:INCL S2:J1-J4	28480	04260-7032	1
04260-8542	CABLE:DIAL	28480	04260-8542	1
04260-8602	TRANSFORMER:POWER	28480	04260-8602	1
04260-8603	TRANSFORMER:OSC	28480	04260-8603	1
04260-8604	R:FXD WW 0,986 OHM 0,3%	28480	04260-8604	1
04260-7022	ASSY:POWER SUPPLY AND 1KHZ OSC	28480	04260-7022	1
04260-7023	ASSY:REFERENCE VOLTAGE	28480	04260-7023	1

See list of abbreviations in introduction to this section

Table 6-3. Manufacturer's Code List

The following code numbers are from the Federal Supply Code for Manufacturers Cataloging Handbooks H4-1 (Name to Code) and H4-2 (Code to Name) and their latest supplements. The date of revision and the date of the supplements used appear at the bottom of each page. Alphabetical codes have been arbitrarily assigned to suppliers not appearing in the H4 handbooks.

Code No.	Manufacturer	Address	Code No.	Manufacturer	Address	Code No.	Manufacturer	Address	Code No.	Manufacturer	Address
06007	J.S.A. Comm.	Any supplier of U.S.	07137	Transistor Electronics Corp.	Minneapolis, Minn.	7262	General Atomics Corp.	Philadelphia, Pa.	72825	Hugh H. Co. Inc.	Philadelphia, Pa.
06134	McDerm Electronics	Mount Holly Springs, Pa.	07138	Westinghouse Electric Corp.	Electronics Tube Div.	11026	Excelsior, Inc.	New York, N.Y.	72828	Ducommun Co.	Chicago, Ill.
06203	Page Electronics Corp.	Rochester, N.Y.	07149	Fairchild Corp.	Elmsford, N.Y.	11570	Fansteel Metallurgical Corp.	No. Chicago, Ill.	72864	Robert M. Hayes Co.	Los Angeles, Calif.
06254	Parcraft	Elmer, Calif.	07233	Chrom-Graphics Co.	City of Industry, Calif.	11525	The Fatour Bearing Co.	New Britain, Conn.	72867	Eric Technol. Prod. Co.	Erie, Pa.
06273	Parlock Inc.	Elmer, Calif.	07261	Avnet Corp.	Los Angeles, Calif.	12455	G.E. Lamp Division	Neia Park, Cleveland, Ohio	73061	Hansen Mfg. Co., Inc.	Princeton, Ind.
06284	Electronics Products Div.	Carleon, N.J.	07263	Fairchild Camera & Inst. Corp.	Semiconductor Div.	12455	General Radio Co.	West Concord, Mass.	73076	H.M. Hayes Co.	Chicago, Ill.
06286	Avco Corp.	New Bedford, Mass.	07322	Minnesota Rubber Co.	Mountain View, Calif.	26365	GRES Reproductor Corp.	New Rochelle, N.Y.	73138	Helipot Co. of Brockman Inst., Inc.	Fallston, Calif.
06273	Avco, Inc.	Harrisburg, Pa.	07328	The Ballen Corp.	Los Angeles, Calif.	26467	Grobel File Co. of America, Inc.	Carlstadt, N.J.	73293	Hughes Products Division of Hughes Aircraft Co.	Newport Beach, Calif.
06276	Aerostat Radio Corp.	Edison, N.J.	07366	Technical Wire Products Inc.	San Leandro, Calif.	26467	Grobel File Co. of America, Inc.	Carlstadt, N.J.	73445	Ampere Electronic Co., Div. of North American Philips Co., Inc.	Hicksville, N.Y.
06283	Western Engineering Laboratories, Inc.	Burlington, Wis.	07910	Confidential Device Corp.	Hawthorne, Calif.	26467	Grobel File Co. of America, Inc.	Carlstadt, N.J.	73506	Biodyne Semiconductor Corp.	Hamden, Conn.
06283	Sergano Electric Co., Packens Div.	Pelicans, S.C.	07933	Semiconductor Div.	Mountain View, Calif.	26467	Grobel File Co. of America, Inc.	Carlstadt, N.J.	73559	Carling Electric, Inc.	Hartford, Conn.
06284	Cite Engineering Co.	Los Angeles, Calif.	07966	Shockley Semi-Conductor Laboratories	Pate Alto, Calif.	26467	Grobel File Co. of America, Inc.	Carlstadt, N.J.	73687	George A. Connet Co., Div. MSL Industries Inc.	Philadelphia, Pa.
06285	Carl E. Holmes Corp.	Los Angeles, Calif.	07980	Boontes Radio Corp.	Rockaway, N.J.	26467	Grobel File Co. of America, Inc.	Carlstadt, N.J.	73734	Federal Screw Products Inc.	Chicago, Ill.
06286	Allen Bradley Co.	Milwaukee, Wis.	08145	U.S. Engineering Co.	Los Angeles, Calif.	26467	Grobel File Co. of America, Inc.	Carlstadt, N.J.	73743	Fischer Special Mfg. Co.	Cincinnati, Ohio
06286	Litton Industries, Inc.	Beverly Hills, Calif.	08289	Blinn, DeBent, Co.	Pomona, Calif.	26467	Grobel File Co. of America, Inc.	Carlstadt, N.J.	73753	The General Industries Co.	Elyria, Ohio
06286	TSM Instruments, Inc.	Transistor Products Div.	08558	Buggess Battery Co.	Niagara Falls, Ontario, Canada	26467	Grobel File Co. of America, Inc.	Carlstadt, N.J.	73846	Goshen Stamping & Tool Co.	Goshen, Ind.
06286	Transistor Products Div.	Dallas, Texas	08564	The Bristol Co.	Waterbury, Conn.	26467	Grobel File Co. of America, Inc.	Carlstadt, N.J.	73859	JFD Electronics Corp.	Brocklyn, N.Y.
06286	The Alliance Mfg. Co.	Allard, Ohio	08571	Sloan Company	Sun Valley, Calif.	26467	Grobel File Co. of America, Inc.	Carlstadt, N.J.	73905	Jennings Radio Mfg. Corp.	San Jose, Calif.
06286	Carl E. Holmes Corp.	Los Angeles, Calif.	08718	ITT Cannon Electric Inc.	Phoenix, Arizona	26467	Grobel File Co. of America, Inc.	Carlstadt, N.J.	74276	Signalite Inc.	Newport, N.J.
06286	Allen Bradley Co.	Milwaukee, Wis.	08792	CBS Electronics Semiconductor Operations, Div. of C.B.S., Inc.	Lowell, Mass.	26467	Grobel File Co. of America, Inc.	Carlstadt, N.J.	74455	J.M. Winsor, Inc. Sons	Winchester, Mass.
06286	Litton Industries, Inc.	Beverly Hills, Calif.	08884	Mel-Ram	Indianapolis, Ind.	26467	Grobel File Co. of America, Inc.	Carlstadt, N.J.	74851	Industrial Condenser Corp.	Chicago, Ill.
06286	TSM Instruments, Inc.	Transistor Products Div.	09026	Babcock Relays Div.	Houston, Texas	26467	Grobel File Co. of America, Inc.	Carlstadt, N.J.	74868	R.F. Products Division of Amphenol-Borg Electronics Corp.	Danbury, Conn.
06286	Transistor Products Div.	Dallas, Texas	09134	Texas Capacitor Co.	Houston, Texas	26467	Grobel File Co. of America, Inc.	Carlstadt, N.J.	74970	E.F. Johnson Co.	Wesaca, Minn.
06286	The Alliance Mfg. Co.	Allard, Ohio	09145	Atom Electronics, Inc.	Chicago, Ill.	26467	Grobel File Co. of America, Inc.	Carlstadt, N.J.	75042	International Resistance Co.	Philadelphia, Pa.
06286	Carl E. Holmes Corp.	Los Angeles, Calif.	09250	Electro Assemblies, Inc.	Chicago, Ill.	26467	Grobel File Co. of America, Inc.	Carlstadt, N.J.	75378	James Keegan Co.	Sandwich, Ill.
06286	Allen Bradley Co.	Milwaukee, Wis.	09569	Mallory Battery Co. of Canada, Ltd.	Toronto, Ontario, Canada	26467	Grobel File Co. of America, Inc.	Carlstadt, N.J.	75382	Kulka Electric Corporation	Mt. Vernon, N.Y.
06286	Litton Industries, Inc.	Beverly Hills, Calif.	10214	General Transistor Western Corp.	Berkeley, Calif.	26467	Grobel File Co. of America, Inc.	Carlstadt, N.J.	75818	Lenz Electric Mfg. Co.	Chicago, Ill.
06286	TSM Instruments, Inc.	Transistor Products Div.	10411	Ti-Tal, Inc.	Berkeley, Calif.	26467	Grobel File Co. of America, Inc.	Carlstadt, N.J.	75915	Littelfuse, Inc.	Des Plaines, Ill.
06286	Transistor Products Div.	Dallas, Texas	10646	Carborundum Co.	Niagara Falls, N.Y.	26467	Grobel File Co. of America, Inc.	Carlstadt, N.J.	76005	Loe Mfg. Co.	Erie, Pa.
06286	The Alliance Mfg. Co.	Allard, Ohio	11216	CTS of Berne, Inc.	Berne, Ind.	26467	Grobel File Co. of America, Inc.	Carlstadt, N.J.	76210	C.W. Marweel	San Francisco, Calif.
06286	Carl E. Holmes Corp.	Los Angeles, Calif.	11237	Chicago Telephone of California, Inc.	So. Pasadena, Calif.	26467	Grobel File Co. of America, Inc.	Carlstadt, N.J.	76433	General Instrument Corp., Micronal Div.	Newark, N.J.
06286	Allen Bradley Co.	Milwaukee, Wis.	11242	Bay State Electronics Corp.	Waltham, Mass.	26467	Grobel File Co. of America, Inc.	Carlstadt, N.J.	76487	James Miller Mfg. Co., Inc.	Malden, Mass.
06286	Litton Industries, Inc.	Beverly Hills, Calif.	11312	Microwave Electronics Corp.	Palo Alto, Calif.	26467	Grobel File Co. of America, Inc.	Carlstadt, N.J.	76493	J.W. Miller Co.	Los Angeles, Calif.
06286	TSM Instruments, Inc.	Transistor Products Div.	11334	Duncan Electronics Inc.	Costa Mesa, Calif.	26467	Grobel File Co. of America, Inc.	Carlstadt, N.J.	76530	Monadnock Mills	San Leandro, Calif.
06286	Transistor Products Div.	Dallas, Texas	11713	General Instrument Corp., Semiconductor Products Group	Newark, N.J.	26467	Grobel File Co. of America, Inc.	Carlstadt, N.J.	76545	Mueller Electric Co.	Cleveland, Ohio
06286	The Alliance Mfg. Co.	Allard, Ohio	11717	Imperial Electronic, Inc. Melabs, Inc.	Buena Park, Calif.	26467	Grobel File Co. of America, Inc.	Carlstadt, N.J.	76554	Oak Manufacturing Co.	Crystal Lake, Ill.
06286	Carl E. Holmes Corp.	Los Angeles, Calif.	11870	Philadelphie Handle Co.	Camden, N.J.	26467	Grobel File Co. of America, Inc.	Carlstadt, N.J.	77058	The Bender Corp.	Chicago, Ill.
06286	Allen Bradley Co.	Milwaukee, Wis.	12897	Glorostat Mfg. Co.	Dover, N.H.	26467	Grobel File Co. of America, Inc.	Carlstadt, N.J.	77075	Benix Pacific Div.	No. Hollywood, Calif.
06286	Litton Industries, Inc.	Beverly Hills, Calif.	12859	Nippon Electric Co., Ltd.	Tokyo, Japan	26467	Grobel File Co. of America, Inc.	Carlstadt, N.J.	77221	Pacific Metals Co.	San Francisco, Calif.
06286	TSM Instruments, Inc.	Transistor Products Div.	12883	Melex Electronics Corp.	Clark, N.J.	26467	Grobel File Co. of America, Inc.	Carlstadt, N.J.	77272	Phosphor Instrument and Electronic Co.	South Pasadena, Calif.
06286	Transistor Products Div.	Dallas, Texas	12930	Delta Semiconductor Inc.	Newport Beach, Calif.	26467	Grobel File Co. of America, Inc.	Carlstadt, N.J.	77252	Philadelphie Steer and Wire Corp.	Philadelphia, Pa.
06286	The Alliance Mfg. Co.	Allard, Ohio	13103	Thermoloy	Dallas, Texas	26467	Grobel File Co. of America, Inc.	Carlstadt, N.J.	77342	American Machine & Foundry Co.	Princeton, Ind.
06286	Carl E. Holmes Corp.	Los Angeles, Calif.	13296	Telefunken (G.M.B.H.)	Mannover, Germany	26467	Grobel File Co. of America, Inc.	Carlstadt, N.J.	77360	Potter & Bramfield Div.	Princeton, Ind.
06286	Allen Bradley Co.	Milwaukee, Wis.	13835	Midland-Wright Div. of Pacific Industries, Inc.	Kansas City, Kansas	26467	Grobel File Co. of America, Inc.	Carlstadt, N.J.	77630	TRW Electronic Components Div.	Camden, N.J.
06286	Litton Industries, Inc.	Beverly Hills, Calif.	14099	Sem-Tech	Newbury Park, Calif.	26467	Grobel File Co. of America, Inc.	Carlstadt, N.J.	77638	General Instrument Corp., Rectifier Div.	Brooklyn, N.Y.
06286	TSM Instruments, Inc.	Transistor Products Div.	14193	Calif. Resistor Corp.	Santa Monica, Calif.	26467	Grobel File Co. of America, Inc.	Carlstadt, N.J.	77764	Resistance Products Co.	Harrisburg, Pa.
06286	Transistor Products Div.	Dallas, Texas	14298	American Components, Inc.	Conshohocken, Pa.	26467	Grobel File Co. of America, Inc.	Carlstadt, N.J.	77969	Rubbercraft Corp. of Calif.	Torrance, Calif.
06286	The Alliance Mfg. Co.	Allard, Ohio	14493	Hewlett-Packard Company	Loveland, Colo.	26467	Grobel File Co. of America, Inc.	Carlstadt, N.J.	78189	Shakeproof Division of Illinois Tool Works	Elgin, Ill.
06286	Carl E. Holmes Corp.	Los Angeles, Calif.	14655	Cornell Dublier Electric Corp.	Newark, N.J.	26467	Grobel File Co. of America, Inc.	Carlstadt, N.J.	78283	Signal Indicator Corp.	New York, N.Y.
06286	Allen Bradley Co.	Milwaukee, Wis.	14960	Williams Mfg. Co.	San Jose, Calif.	26467	Grobel File Co. of America, Inc.	Carlstadt, N.J.	78290	Stethers-Gunn Inc.	Pittsford, N.Y.
06286	Litton Industries, Inc.	Beverly Hills, Calif.	15263	Webster Electronics Co.	New York, N.Y.	26467	Grobel File Co. of America, Inc.	Carlstadt, N.J.	78452	Thompson-Bremer & Co.	Chicago, Ill.
06286	TSM Instruments, Inc.	Transistor Products Div.	15291	Adjustable Bushing Co.	Hollywood, Calif.	26467	Grobel File Co. of America, Inc.	Carlstadt, N.J.	78471	Tilley Mfg. Co.	San Francisco, Calif.
06286	Transistor Products Div.	Dallas, Texas	15558	Micron Electronics	Garden City, Long Island, N.Y.	26467	Grobel File Co. of America, Inc.	Carlstadt, N.J.	78471	Tilley Mfg. Co.	San Francisco, Calif.
06286	The Alliance Mfg. Co.	Allard, Ohio	15722	Twentieth Century Coil Spring Co.	Santa Clara, Calif.	26467	Grobel File Co. of America, Inc.	Carlstadt, N.J.	78486	Stackpole Carbon Co.	St. Marys, Pa.
06286	Carl E. Holmes Corp.	Los Angeles, Calif.	15818	Ameico Inc.	Mt. View, Calif.	26467	Grobel File Co. of America, Inc.	Carlstadt, N.J.	78493	Standard Thomson Corp.	Waltham, Mass.
06286	Allen Bradley Co.	Milwaukee, Wis.	15909	Daven Div. Thomas A. Edison Ind.	Long Island City, N.Y.	26467	Grobel File Co. of America, Inc.	Carlstadt, N.J.	78553	Tinnerman Products, Inc.	Cleveland, Ohio
06286	Litton Industries, Inc.	Beverly Hills, Calif.	16037	McGraw-Edison Co.	Long Island City, N.Y.	26467	Grobel File Co. of America, Inc.	Carlstadt, N.J.	78790	Transformer Engineers	San Gabriel, Calif.
06286	TSM Instruments, Inc.	Transistor Products Div.	16332	Spruce Pine Mica Co.	Spruce Pine, N.C.	26467	Grobel File Co. of America, Inc.	Carlstadt, N.J.	78947	Umicore Co.	Newtownville, Mass.
06286	Transistor Products Div.	Dallas, Texas	16352	Computer Diode Corp.	Lodi, N.J.	26467	Grobel File Co. of America, Inc.	Carlstadt, N.J.	79136	Waldes Robinson Inc.	Long Island City, N.Y.
06286	The Alliance Mfg. Co.	Allard, Ohio	16688	Ideal Prec. Meter Co., Inc.	Brooklyn, N.Y.	26467	Grobel File Co. of America, Inc.	Carlstadt, N.J.	79142	Veeder Root, Inc.	Hartford, Conn.
06286	Carl E. Holmes Corp.	Los Angeles, Calif.	16758	Delco Radio Div. of G.M. Corp.	Kokomo, Ind.	26467	Grobel File Co. of America, Inc.	Carlstadt, N.J.	79251	Wesco Mfg. Co.	Chicago, Ill.
06286	Allen Bradley Co.	Milwaukee, Wis.	17109	Thermometrics Inc.	Canoga Park, Calif.	26467	Grobel File Co. of America, Inc.	Carlstadt, N.J.	79272	Continental-Wire Electronics Corp.	Philadelphia, Pa.
06286	Litton Industries, Inc.	Beverly Hills, Calif.	17474	Trane Company	Mountain View, Calif.	26467	Grobel File Co. of America, Inc.	Carlstadt, N.J.	79963	Zierick Mfg. Corp.	New Rochelle, N.Y.
06286	TSM Instruments, Inc.	Transistor Products Div.	18476	Ty-Car Mfg. Co., Inc.	Holliston, Mass.	26467	Grobel File Co. of America, Inc.	Carlstadt, N.J.	80031	Mepco Division of Sessions Clock Co.	Morrisstown, N.J.
06286	The Alliance Mfg. Co.	Allard, Ohio	18486	Radio Industries	Des Plaines, Ill.	26467	Grobel File Co. of America, Inc.	Carlstadt, N.J.	80120	Schnitzer Alloy Products Co.	Elizabeth, N.J.
06286	Carl E. Holmes Corp.	Los Angeles, Calif.	18583	Curis Instrument, Inc.	Mt. Kisco, N.Y.	26467	Grobel File Co. of America, Inc.	Carlstadt, N.J.	80130	Times Telegraph Equipment	New York, N.Y.
06286	Allen Bradley Co.	Milwaukee, Wis.	18873	E.J. DuPont and Co., Inc.	Wilmington, Del.	26467	Grobel File Co. of America, Inc.	Carlstadt, N.J.	80131	Electronic Industries Association, Any brand Tube meeting EIA standards-Washington, D.C.	Washington, D.C.
06286	Litton Industries, Inc.	Beverly Hills, Calif.	19315	The Bendix Corp., Eclipse-Pioneer Div.	Teterboro, N.J.	26467	Grobel File Co. of America, Inc.	Carlstadt, N.J.	80207	Unimax Switch, Div. Maxon Electronics Corp.	Wallingford, Conn.
06286	TSM Instruments, Inc.	Transistor Products Div.	19500	Thomas A. Edison Industries, Div. of McGraw-Edison Co.	West Orange, N.J.	26467	Grobel File Co. of America, Inc.	Carlstadt, N.J.	80223	United Transformer Corp.	New York, N.Y.
06286	Transistor Products Div.	Dallas, Texas	19701	Electra Mfg. Co.	Independence, Kansas	26467	Grobel File Co. of America, Inc.	Carlstadt, N.J.	80248	Orford Electric Corp.	Chicago, Ill.
06001S-4C						26467	Grobel File Co. of America, Inc.	Carlstadt, N.J.	80254	Bourns Laboratories, Inc.	Riverside, Calif.
Revised: May, 1965						26467	Grobel File Co. of America, Inc.	Carlstadt, N.J.	80411	Robertshaw Controls Co.	Hillsboro, Ohio
						26467	Grobel File Co. of America, Inc.	Carlstadt, N.J.	80486	Aff Star Products Inc.	Defiance, Ohio
						26467	Grobel File Co. of America, Inc.	Carlstadt, N.J.	80509	Avary Adhesive Label Corp.	Monrovia, Calif.

From: FSC Handbook Supplements
H4-1 Dated DECEMBER 1964
H4-2 Dated MARCH 1967

Table 6-3. Manufacturer's Code List (cont'd)

Code No.	Manufacturer	Address	Code No.	Manufacturer	Address	Code No.	Manufacturer	Address	Code No.	Manufacturer	Address
8151	Homestead Co., Inc.	New York, N.Y.	8152	John Scroggs Co.	Chicago, Ill.	9385	Robbins and Myers, Inc.	New York, N.Y.	9873	General Mills, Inc.	Minneapolis, Minn.
8152	Hevens, Annie, Co., Inc.	Boston, Mass.	8153	Avco Electric Co.	Green Bay, Wis.	9541R	Stevens Mfg. Co., Inc.	Mansfield, Ohio	98821	North Hills Electronics, Inc.	Glen Cove, N.Y.
8153	International Instruments Inc.	Chicago, Conn.	8154	A. J. Cheever Co., Inc.	San Francisco, Calif.	9528E	Howard J. Smith Inc.	Port Monmouth, N.J.	98825	Semiconductor Div. of Clevite Corp.	Waltham, Mass.
8154	Graybill Co.	Chicago, Ill.	8155	IRA Capital Corp.	Chicago, Ill.	93929	C.V. Controls	Livingston, N.J.	9887E	International Electronic Research Corp.	Burlington, Calif.
8155	Israd Transformer Corp.	Yonkers, Calif.	8156	Eastex Controls, Inc.	Bloomington, Ill.	94123	General Cable Corp.	Boynton, N.J.	98156	Colson Technical Corp.	Palmdale, Calif.
8156	Winchester Electronics Co., Inc.	New York, Calif.	8157	Shonken Mfg. Co. Div.	Burlington, N.J.	94124	Raytheon Co., Comp. Div., Ind. Comp. Operations	Quincy, Mass.	98312	Variac Associates	Palmdale, Calif.
8157	Military Specification		8158	H.R. Bove Co.	San Francisco, Calif.	94148	Scientific Electronics Products, Inc.	Loveland, Colo.	98515	Marshall Ind. Elect. Products Div.	San Mateo, Calif.
8158	Walker Products, Inc.	Cincinnati, Ohio	8159	H.M. Braconetti Co.	San Francisco, Calif.	94192	Conliss-Wright Corp. Electronics Div.	East Paterson, N.J.	98524	Control Switch Division, Controls Co. of America	El Segundo, Calif.
8159	International Rectifier Corp.	San Francisco, Calif.	8160	Wheeler Koras, Inc.	Hartford, Conn.	94227	South Chester Corp.	Chester, Pa.	98524	Delavan Electronics Corp.	East Airmo, N.Y.
8160	The Axgax Products Co.	Cambridge, Mass.	8161	Seamless Products Co.	Chicago, Ill.	94330	Tap-O-M Products	Huntington, Ind.	98524	Waco Corporation	Indianapolis, Ind.
8161	Barry Controls, Div. Barry Wright Corp.	Woburn, Mass.	8162	Dutton Precision Products Co., Inc.	Clifton Heights, Pa.	94336	Wire Cloth Products, Inc.	Bellwood, Ill.	98524	Hoffman Electronics Corp. Semiconductor Div.	El Monte, Calif.
8162	Carlee Precision Electric Co.	Chicago, Ill.	8163	Precision Rectifier Products Corp.	San Francisco, Calif.	94652	Weston Pressed Aluminum Corp.	Worcester, Mass.	99957	Technology Instrument Co. of Calif.	Newbury Park, Calif.
8163	Scotti Parady Inc., Cecer Hewitt Electric Div.	Hickory, N.J.	8164	Radio Corp. of America, Electronic Comp. & Devices Div.	Hickory, N.J.	95023	George A. Philbrick Researchers, Inc.	Boston, Mass.			
8164	Jeffers Electronics Division of Speer Carbon Co.	Co. Bldg., Pa.	8165	Weston Fibrous Goods Products Co.	San Francisco, Calif.	95236	Allies Products Corp.	Miami, Fla.			
8165	Faehnd Camera & Instl. Corp., Defense Prod. Division	Clifton, N.J.	8166	Vac Waters & Fibers Inc.	San Francisco, Calif.	95238	Continental Connector Corp.	Woodside, N.Y.			
8166	Maguire Industries, Inc.	Greenwich, Conn.	8167	Tower Mfg. Corp.	Providence, R.I.	95263	Leerrath Mfg. Co., Inc.	Long Island, N.Y.			
8167	Sylvania Electric Prod. Inc. Electronic Tube Division	Emporium, Pa.	8168	Cutler-Hammer, Inc.	Long Island, N.Y.	95264	Lesco Electronics, Inc.	Buttana, Calif.			
8168	Astron Division, Renwell Industries Inc.	East New York, N.J.	8169	Cold-National Batteries, Inc.	St. Paul, Minn.	95265	National Coil Co.	Sheridan, Wyo.			
8169	Switchcraft, Inc.	Chicago, Ill.	8170	Federal Telephone & Radio Corp.	Chicago, Ill.	95275	Vileman, Inc.	Bridgeport, Conn.			
8170	Metals & Controls Inc. Spencer Products	Attleboro, Mass.	8171	General Mills, Inc.	Buffalo, N.Y.	95348	Garcos Corp.	Bloomfield, N.J.			
8171	Phillips-Advance Control Co.	Chicago, Ill.	8172	Graybar Electric Co.	Overland Park, Kan.	95354	Methodo Mfg. Co.	Chicago, Ill.			
8172	Research Products Corp.	Madison, Wis.	8173	General Electric Distributing Corp.	Schenectady, N.Y.	95372	Dage Electric Co., Inc.	Franklin, Ind.			
8173	Roten Mfg. Co., Inc.	Waco, N.Y.	8174	United Transformer Co.	Chicago, Ill.	95387	Weckesser Co.	Chicago, Ill.			
8174	Vector Electronic Co.	Glendale, Calif.	8175	US Rubber Co., Consumer Ind. & Plast. Prod. Div.	Franklin, N.J.	96067	Huggins Laboratories	Sunnyvale, Calif.			
8175	Western Washer Mfg. Co.	Los Angeles, Calif.	8176	Beating Engineering Co.	San Francisco, Calif.	96095	Hi-Q Div. of Aerovox Corp.	Olean, N.Y.			
8176	Carl Fastener Co.	Cambridge, Mass.	8177	Connor Spring Mfg. Co.	San Francisco, Calif.	96256	Thordarson-Weissner Div. of Maguire Industries, Inc.	El Carmel, Ill.			
8177	New Hampshire Ball Bearing, Inc.	Peterborough, N.H.	8178	Walter Dial & Nameplate Co.	El Monte, Calif.	96296	Solai Manufacturing Co.	Los Angeles, Calif.			
8178	General Instrument Corp., Capacitor Div.	Carlington, S.C.	8179	Radio Materials Co.	Chicago, Ill.	96330	Carlton Screw Co.	Chicago, Ill.			
8179	ITT Wire and Cable Div.	Los Angeles, Calif.	8180	Augat Inc.	Attleboro, Mass.	96331	Microwave Associates, Inc.	Burlington, Mass.			
8180	Victory Engineering Corp.	Springfield, N.J.	8181	Dale Electronics, Inc.	Colton, Cal.	96501	Excel Transformer Co.	Oakland, Calif.			
8181	Bendix Corp., Red Bank Div.	Red Bank, N.J.	8182	Elco Corp.	Willow Grove, Pa.	97464	Industrial Retaining Ring Co.	Irvine, N.J.			
8182	Hubbell Corp.	Mundeville, Ill.	8183	Grenar Mfg. Co., Inc.	Waketown, Mass.	97539	Automatic & Precision Mfg.	Englewood, N.J.			
8183	Smith, Herman H., Inc.	Brooklyn, N.Y.	8184	K.F. Development Co.	Redwood City, Calif.	97929	Reon Resistor Corp.	Yonkers, N.Y.			
8184	Central Screw Co.	Chicago, Ill.	8185	Honeywell Int., Micro Switch Div.	Freeport, N.Y.	97983	Litton System Inc., Adfer-Westric Common. Div.	New Rochelle, N.Y.			
8185	Gavitt Wire and Cable Co. Div. of Amerace Corp.	Bicochfield, Mass.	8186	Bann-Bios. Spring Co.	Oakland, Calif.	98141	R-Tronics, Inc.	Jamaica, N.Y.			
8186	Burroughs Corp. Electronic Tube Div.	Plainfield, N.J.	8187	Tri-Connector Corp.	Peabody, Mass.	98159	Rubber Tech, Inc.	Gardena, Calif.			
8187	Evereedy Div. National Carbon Div. Union Carbide Corp.	New York, N.Y.	8188	Etgeel Optical Co., Inc.	Rochester, N.Y.	98220	Francis L. Moseley	So. Pasadena, Calif.			
8188	Model Eng. and Mfg., Inc.	Huntington, Ind.	8189	Universal Industries, Inc.	City of Industry, Calif.	98228	Microdot, Inc.	San Bernardino, Calif.			
			8190	Tensolite Insulated Wire Co., Inc.	Tarrytown, N.Y.	98291	Sealtech Corp.	Redwood City, Calif.			
			8191	Sylvania Electric Prod. Inc. Semiconductor Div.	Woburn, Mass.	98405	Carad Corp.	Redwood City, Calif.			

00015-40
Revised: May, 1965

From: FSC, Handbook Supplements
HA-1 Dated DECEMBER 1964
HA-2 Dated MARCH 1962

SECTION VII MANUAL CHANGES AND OPTIONS

7-1. OPTIONS

7-2. Options are standard modifications performed on -hp- instruments at the factory. No options for the Model 4260A are offered at the present time.

7-3. SPECIAL INSTRUMENTS

7-4. "Specials" are standard -hp- instruments that are modified according to customer specifications. A separate insert sheet is included with the manual for special instruments having electrical changes. Make the changes specified in addition to any other changes that are necessary.

7-5. MANUAL CHANGES

7-6. This manual applies directly to the Model 4260A with serials prefixed 845/846-. The following paragraphs explain how to adapt this manual to apply to later instruments with higher serial prefix, or earlier instruments with lower serial prefix. Technical corrections to this manual (if any) are called errata and are listed on a separate "Manual Changes" sheet supplied with this manual.

7-7. LATER INSTRUMENTS: If the serial prefix of your Model 4260A is above 845.846-, refer to a separate "Manual Changes" sheet supplied with this manual. Locate the serial prefix of your instrument and make the indicated changes.

7-8. EARLIER INSTRUMENTS (Backdating Changes): If the serial prefix of your Model 4260A is below 845/846-, refer to table 7-1 for the changes necessary to adapt this manual to your particular instrument. Locate the serial prefix of your instrument in the table and make the indicated changes. Note that instrument-component values that differ from those in this manual, yet are not listed in this backdating changes, should be replaced using the part number given in this manual.

CHANGE 1

Delete: C423 0160-1038 20pF

CHANGE 2

Delete: C7 0160-1303 0.1μF
CR3, CR4 1910-0040
R8 0684-2721 2700 OHM

CHANGE 3

Page 3-2, Figure 3-1
Change the picture of Rear Panel as shown in Figure 7-1.

Page 6-8, Table 6-1
Change A500 to 04260-7025.

Page 6-9, Table 6-1
Change F1 to 2110-0110, FUSE:
CARTRIDGE SLO-BLO 0.1A.

Page 6-10, Table 6-1
Change W1 to 8120-0078.
Change 04260-1085 to 04260-1080.
Change 7120-0492 to 7120-0445.
Delete 7120-0495.

Page 6-13, Table 6-2
Change 8120-1348 to 8120-0078.
Change 04260-1085 to 04260-1080.

Page 6-14, Table 6-2
Change 04260-7053 to 04260-7025.

Serial Prefix or Number	Make Following Changes
601/602-	1, 2, 3, 5, 6
711/712- and below	2, 3, 5, 6
845/846- and below	3, 5, 6
1023/1024 and below	4, 6
1111J/1112J and below	5, 6
1133J/1134J and below	6
1207J/1208J	No change

Table 7-1. Manual Backdating Changes

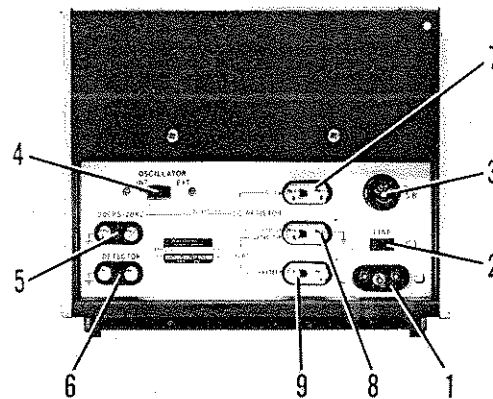

Figure 7-1

CHANGE 4

Page 6-13, Table 6-2

Change 04260-1086 to 04260-1085.

CHANGE 5

Page 6-8, Table 6-1.

Change R458 to 0683-8245, R:FXD COMP
820k Ω 5% 1/4W.

Page 6-9, Table 6-1.

Change V601 and V602 to 2140-0018.
Change R601 to 0687-1541, R:FXD COMP
150k Ω 10% 1/2W.

Page 8-5, 8-6, Figure 8-3.

Change value of R601 to 150k Ω .

Page 8-11, 8-12, Figure 8-6.

Change value of R458 to 820k Ω .

CHANGE 6

Page 6-2, Figure 6-1.

Change 04260-1240 to 04260-1140.
Change 5000-8565 to 5000-0703.
Change 5000-8583 to 5000-0717.
Change 5060-8573 to 5060-0718.

Page 6-3, Table 6-1.

Change 04260-7055 to 04260-7021.
Change S101 to 04260-7021.

Page 6-6, Table 6-1.

Change 04260-7724 to 04260-7024.
Delete: C424, 0160-0168.

Page 6-7, Table 6-1.

Delete: CR422, 1901-0040.
Delete: CR423, 1901-0040.

Page 6-8, Table 6-1.

Delete: R459, 0684-2721.

Page 6-9, Table 6-1.

Change M1 to 1120-0761.

Page 6-10, Table 6-1.

Change 04260-7057 to 04260-7030.
Add: 04260-1082: METER BRACKET.

Page 6-13, Table 6-2.

Change 04260-1240 to 04260-1140.
Change 1120-0768 to 1120-0761.
Add: 04260-1082: METER BRACKET.

Page 6-14, Table 6-2.

Change 04260-7055 to 04260-7021.
Change 04260-7724 to 04260-7024.
Change 04260-7057 to 04260-7030.
Change 3101-0889 to 3101-0206.

Page 8-11/8-12, Figure 8-6.

Change 04260-7724 to 04260-7024.

Change circuit of A400 as shown in partial
schematic, Figure 7-2.

Figure 7-2

Page 6-3, Table 6-1

Change CR206 to 1901-0026 DIODE:SILICON
200PIV 0.5 AMP.

Page 6-13, Table 6-2

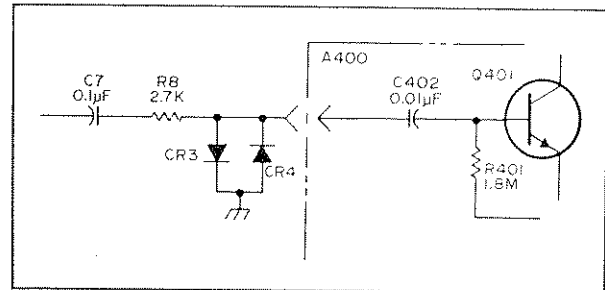
Add: 1901-0026 DIODE:SILICON 200PIV 0.5
AMP.

Change Total Quantity of 1901-0028 to 1.

SECTION VIII CIRCUIT DIAGRAMS

8-1. INTRODUCTION.

8-2. This section includes the following:

- a. General Notes for Schematic Diagrams (Figure 8-1).
- b. Block Diagram (Figure 8-2).
- c. Schematic Diagrams and part location illustrations. Waveforms and voltages at indicated test points are also included.

8-3. The Block Diagram or schematic diagrams can be unfolded and used with any other portion of the manual.

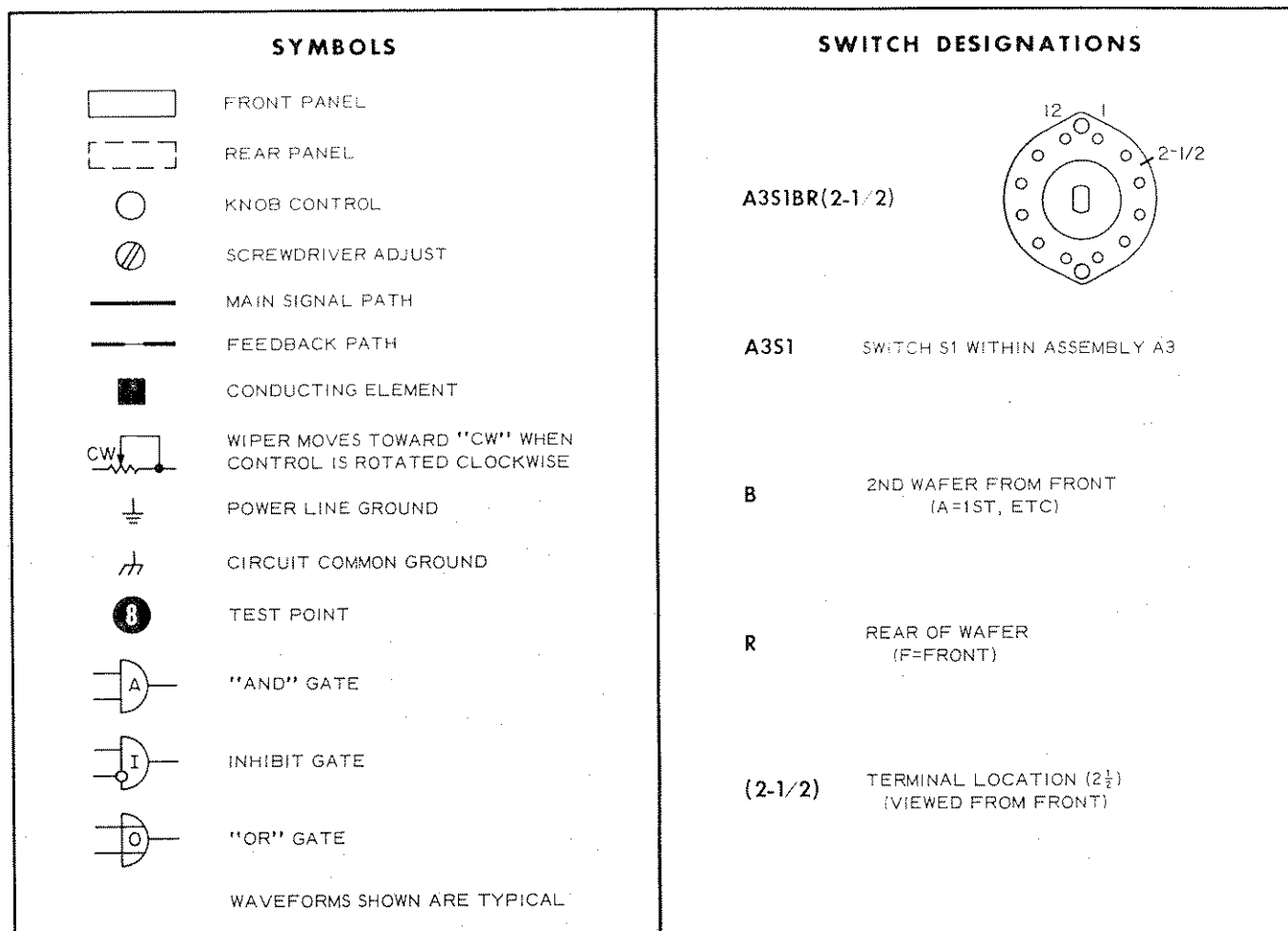

REFERENCE DESIGNATIONS

REFERENCE DESIGNATIONS WITHIN ASSEMBLIES ARE ABBREVIATED. ADD ASSEMBLY NUMBER TO ABBREVIATION FOR COMPLETE DESCRIPTION.

ASSEMBLY	ABBREVIATION	COMPLETE DESCRIPTION
A25	CR1	A25CR1
A25A1	CR1	A25A1CR1
NO PREFIX	J3	J3

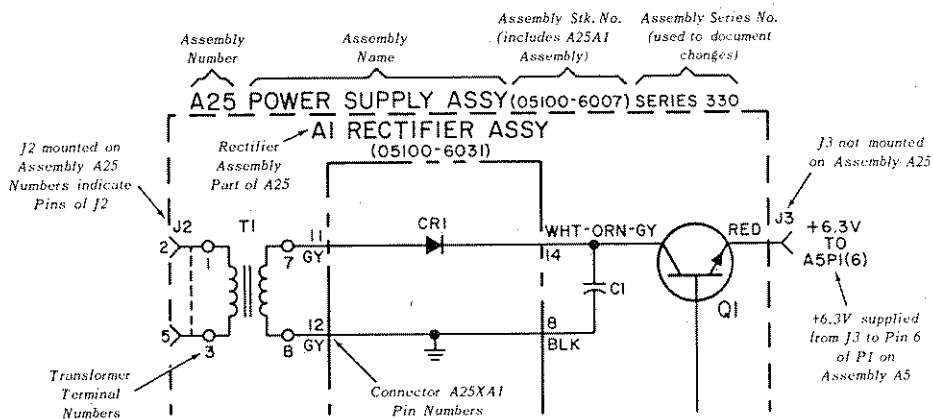
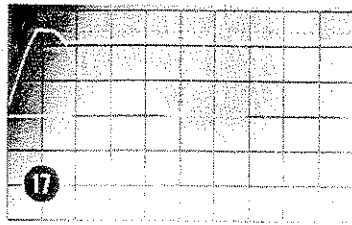
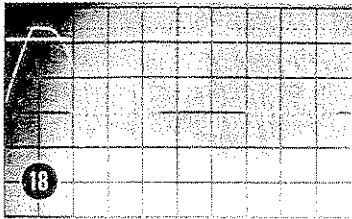

Figure 8-1. Schematic Diagram Notes



17 AND 18
OSCILLOSCOPE*:
VERT = 2V/cm
HORIZ = 200µs/cm



28 AND 29
+1.3V TO -0.4V BIAS
RANGE FOR CR419
AND CR420

DC VOLTAGE DIFFERENCE
BETWEEN 19 AND 20 OR
19 AND 21 IS LESS THAN
10mV WHEN BRIDGE IS
BALANCED

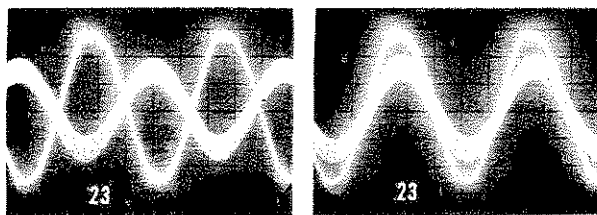
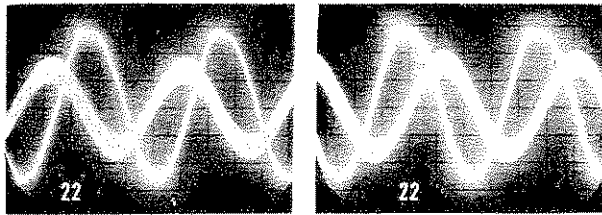

22 AND 23
A. CRL DIAL 0.2% HIGH FROM BALANCE
B. POLARITY REVERSED WITH CRL DIAL 0.2% LOW
OSCILLOSCOPE*: VERT = .1V/cm HORIZ = 200µs/cm

24 5.3 TO 6.1VDC

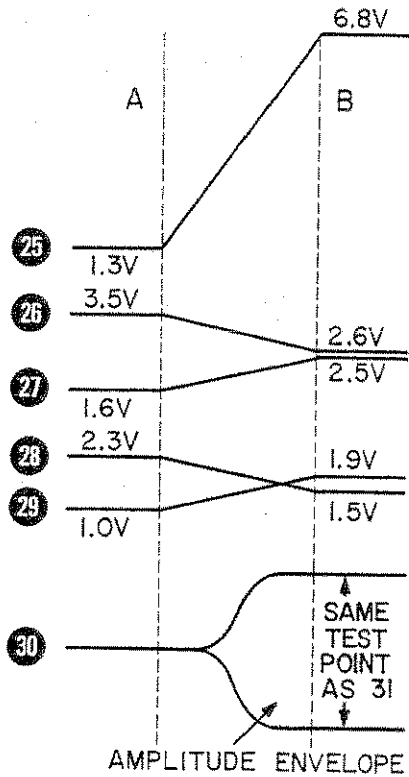

31 SEE PARAGRAPH 5-50

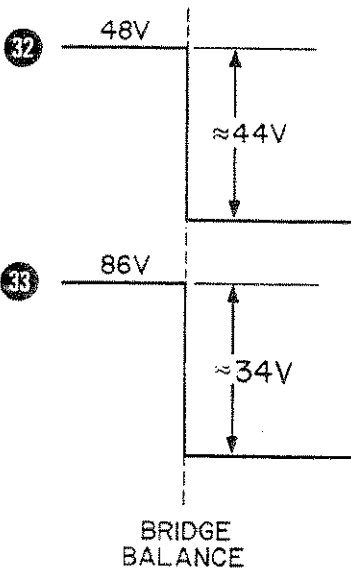

*SEE FIG 8-4 (1kHz OSCILLATOR) 4 FOR COMMON WAVEFORM SETTINGS.
SEE PAGE 5-12 FOR MEASUREMENT PROCEDURE.

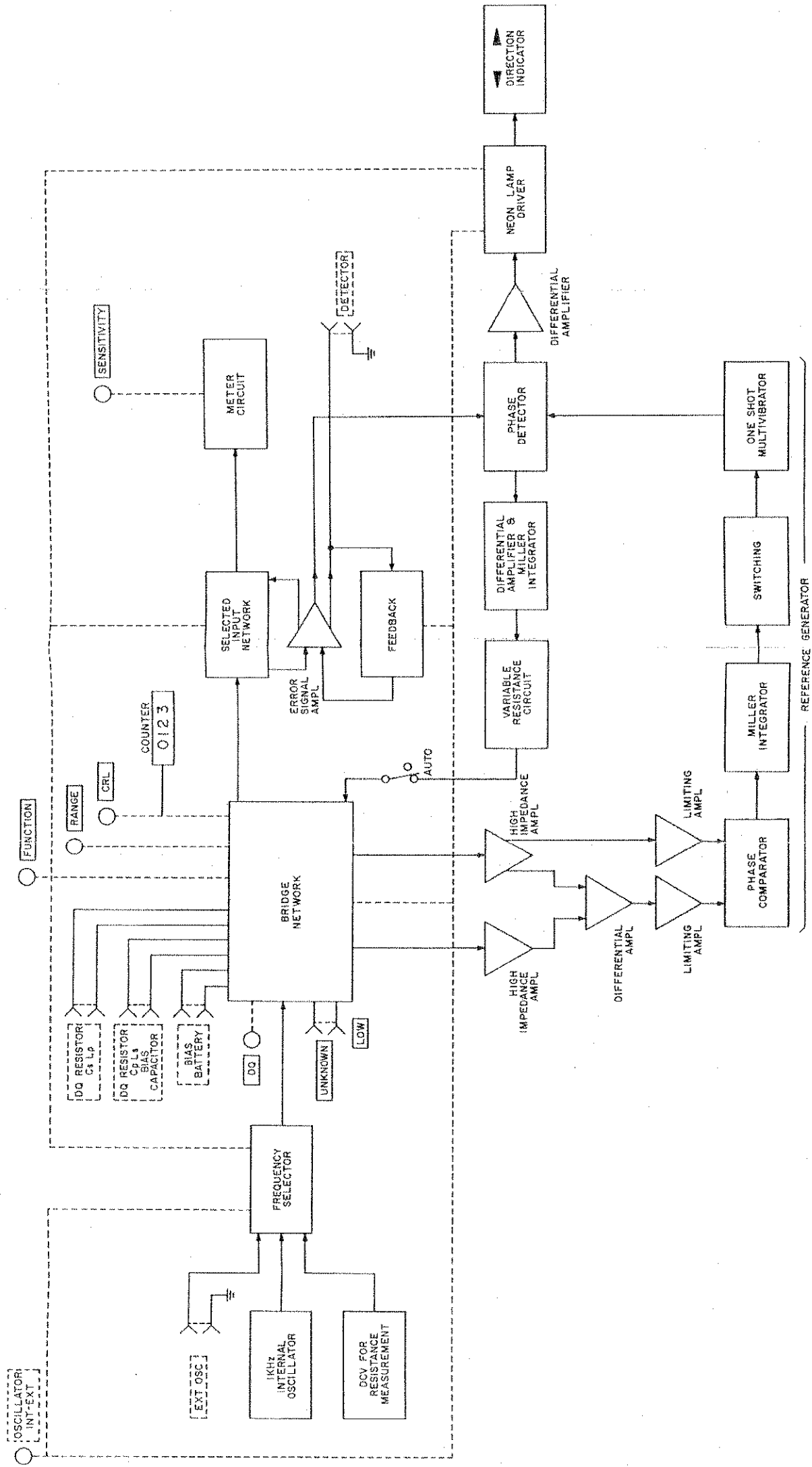
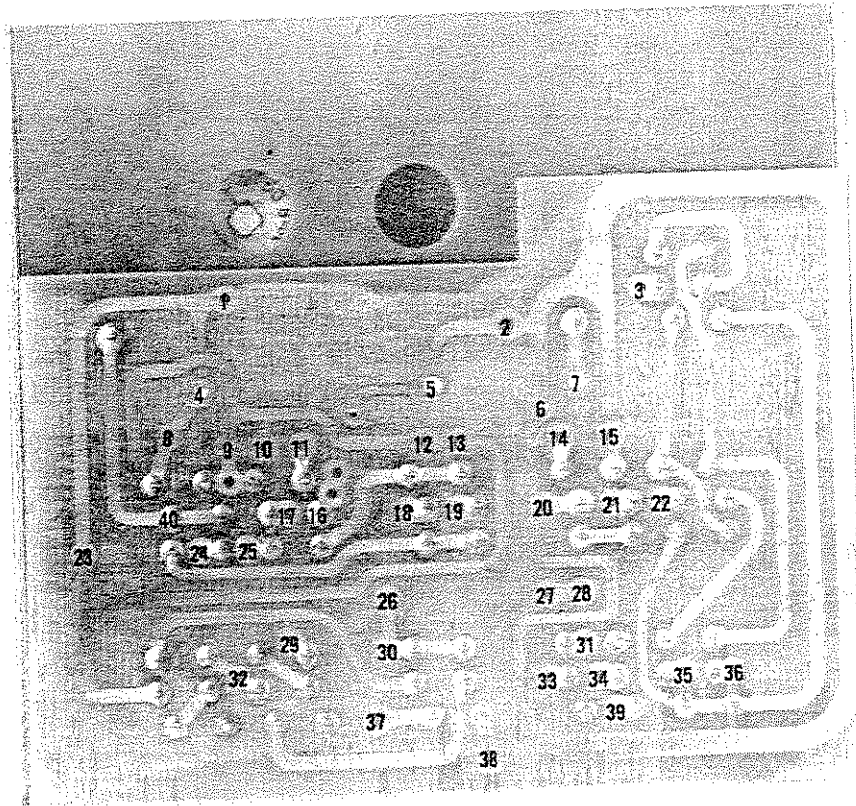
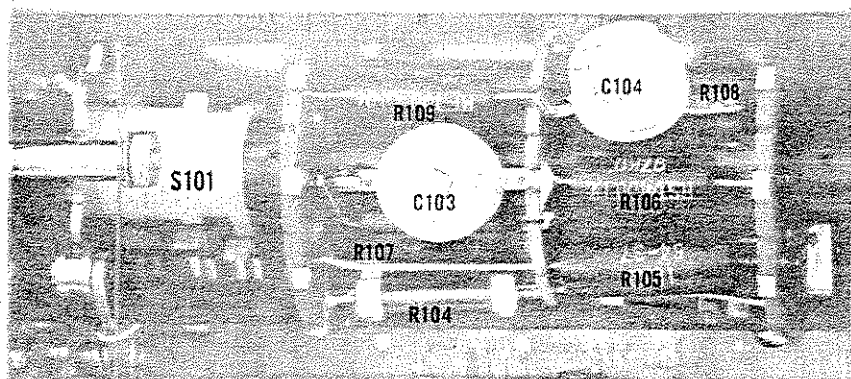
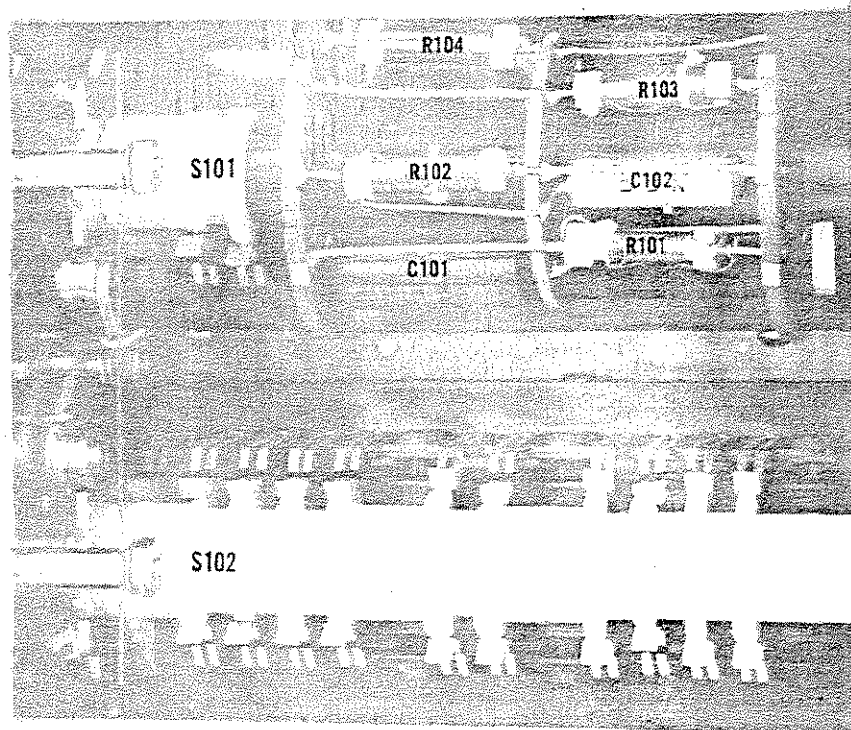

Figure 8-2. Overall Block Diagram
8-3

Section VIII
Figure 8-3



A100



A100

A100 RANGE AND FUNCTION SWITCH ASSEMBLY (04280-7055)

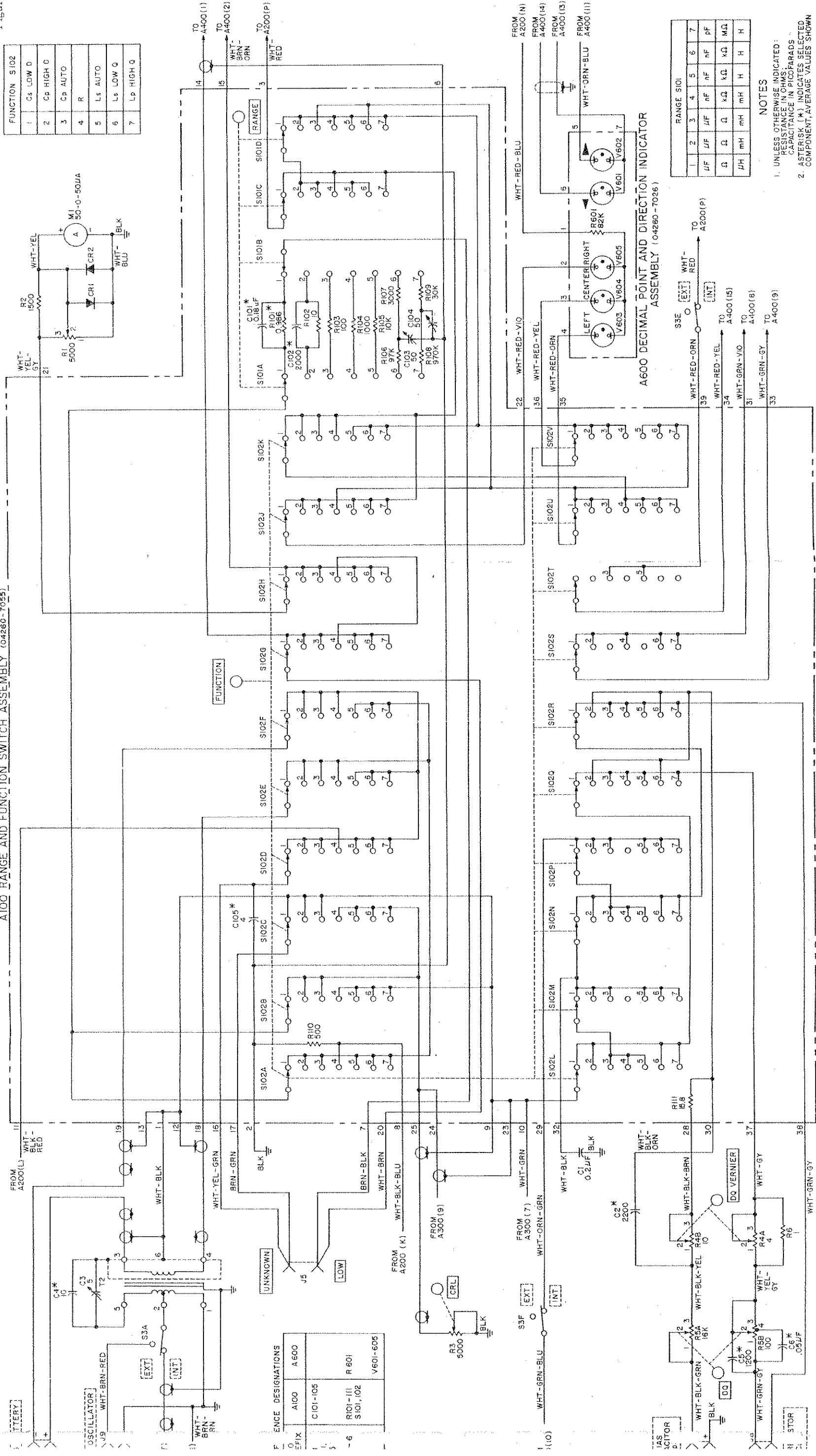

COPYRIGHT 1966 BY HEWLETT-PACKARD COMPANY

Figure 8-3. Range and Function Switch A100
Decimal Point and Direction Light A600
8-5/8-6

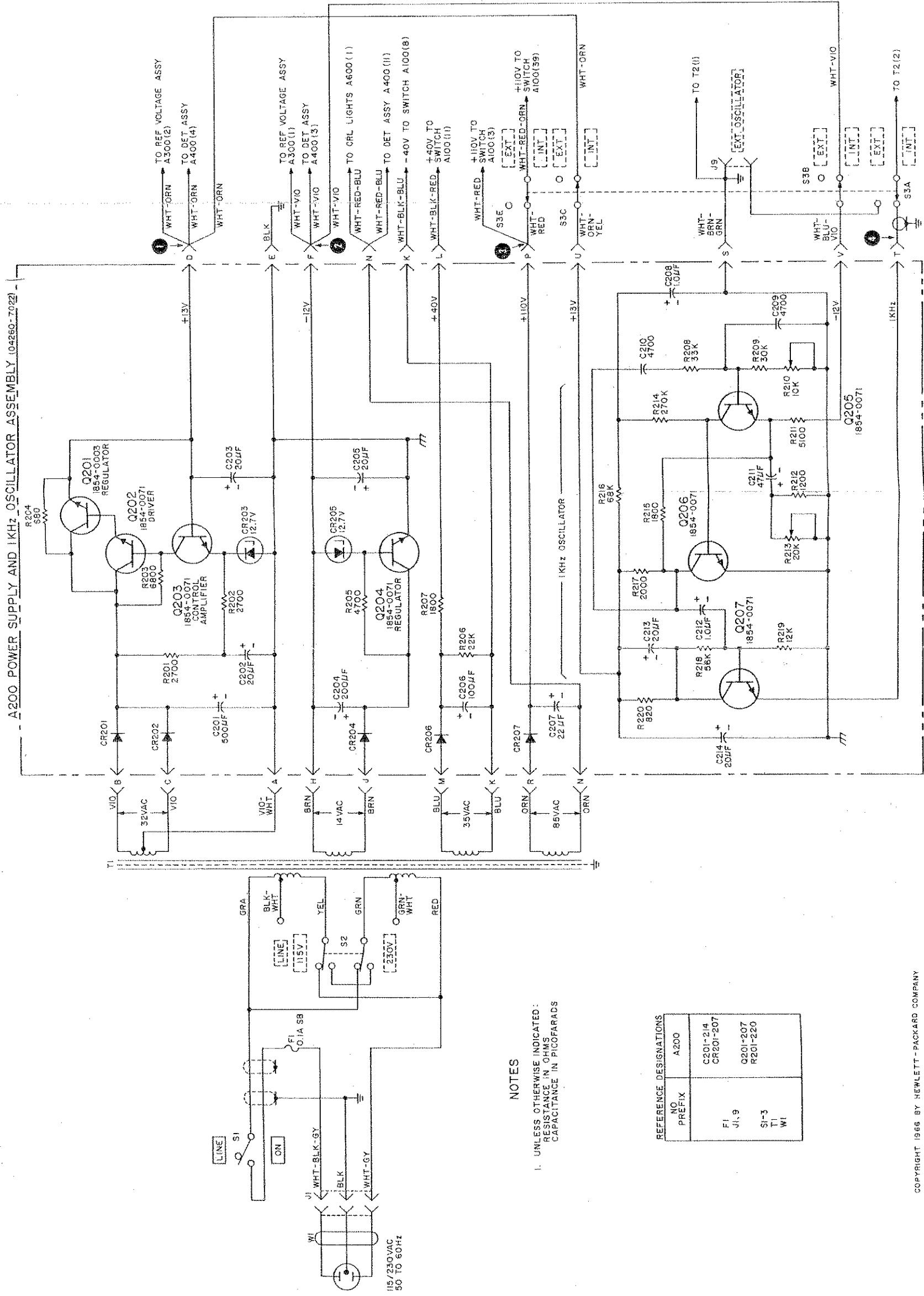
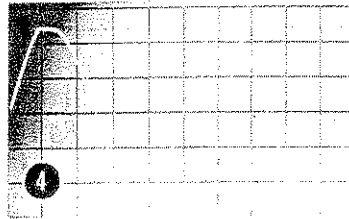
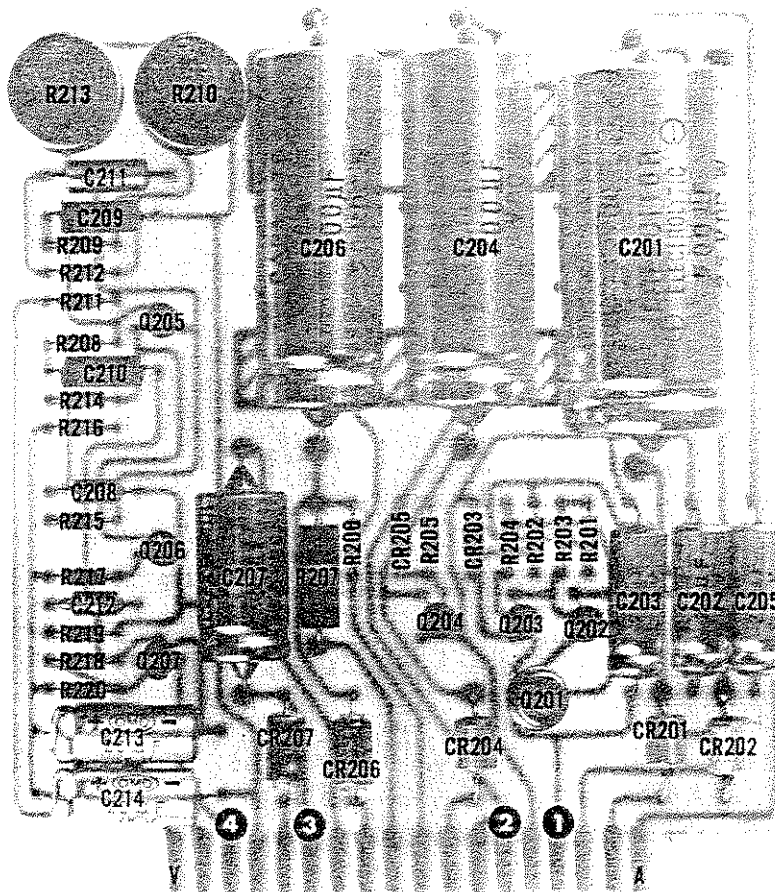

Figure 8-4. Power Supply and 1 kHz Oscillator A200
8-7

- ① +12 TO +13.5VDC
- ② -11 TO -12.5VDC
- ③ +95 TO +115VDC



SWEEP SPEED
200μs/cm
AMPLITUDE
1V/cm



A200

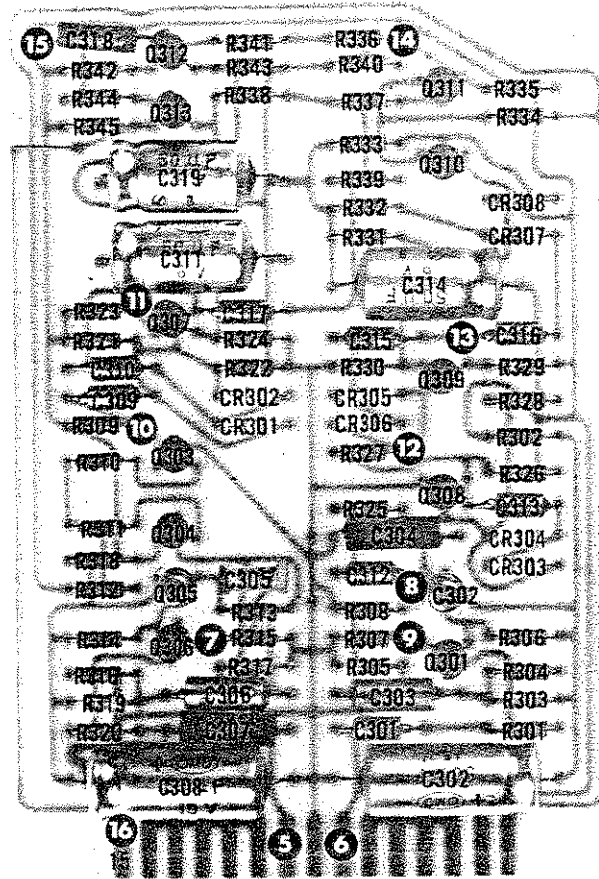

A300

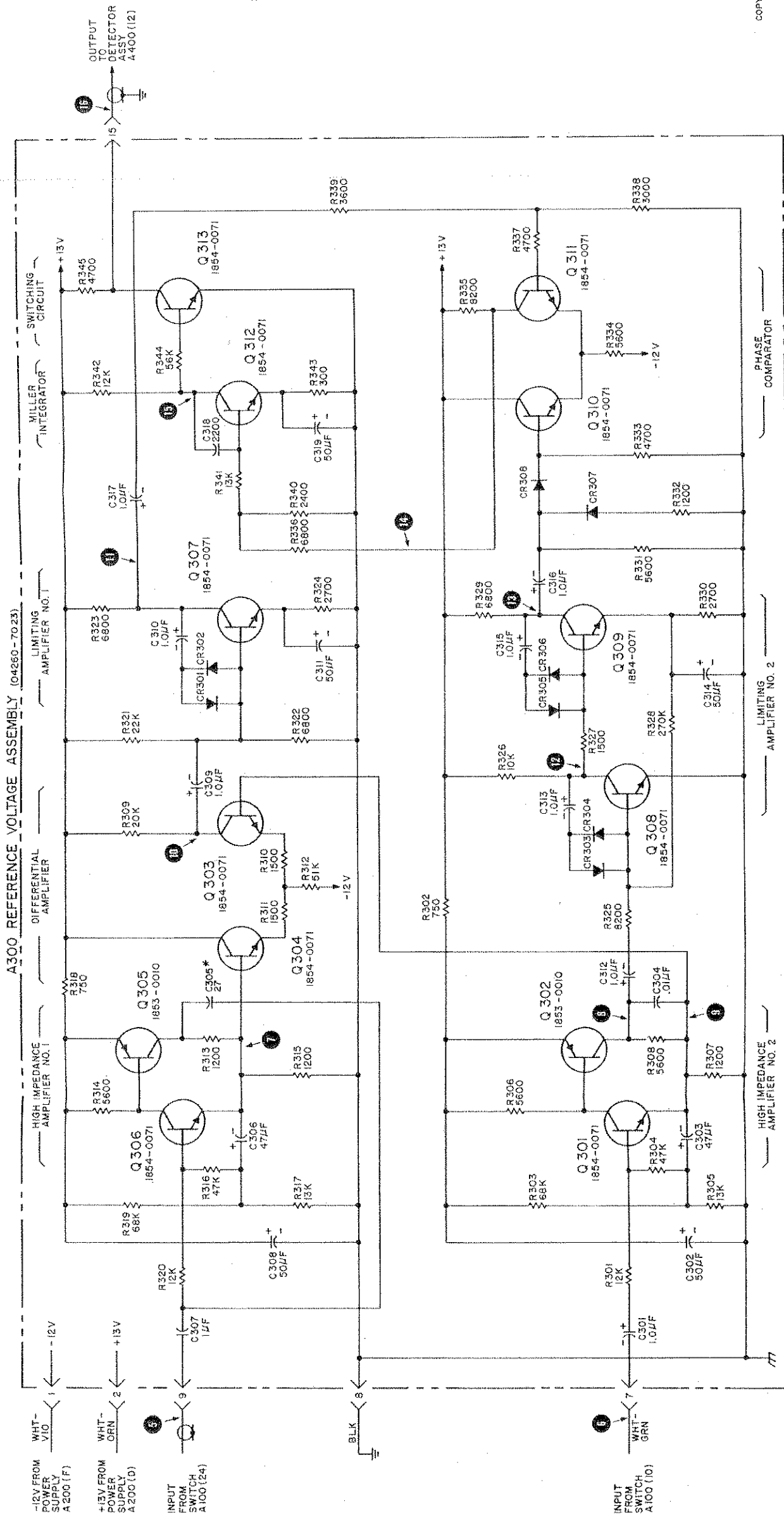

- NOTES**
1. UNLESS OTHERWISE INDICATED: RESISTANCE IN OHMS, CAPACITANCE IN PICOFARADS
 2. ASTERISK (*) INDICATES SELECTED COMPONENT, AVERAGE VALUES SHOWN

REFERENCE DESIGNATIONS

A	300
C	301 - 319
CR	301 - 308
Q	301 - 313
R	301 - 345

COPYRIGHT 1966 BY HEWLETT-PACKARD COMPANY

Figure 8-5. Reference Voltage Assembly A300
8-9

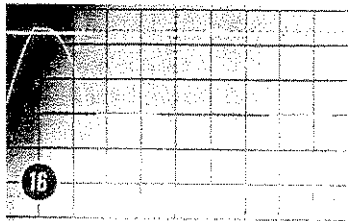
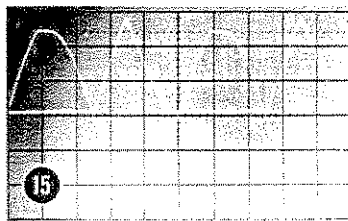
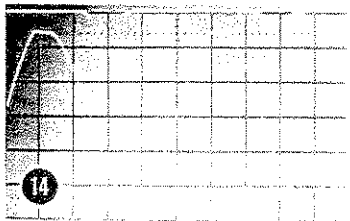
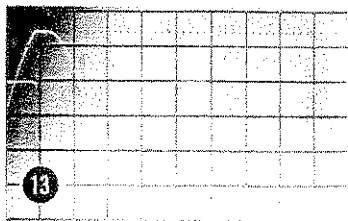
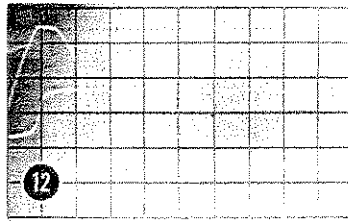
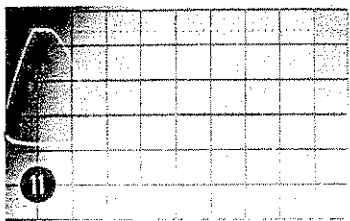
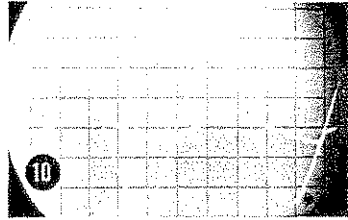
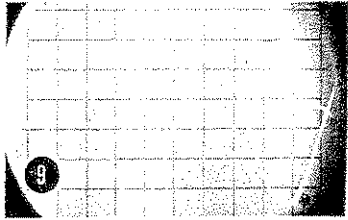
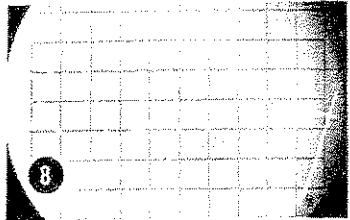
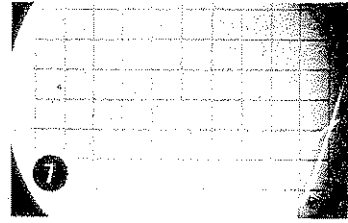
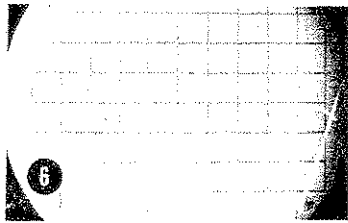
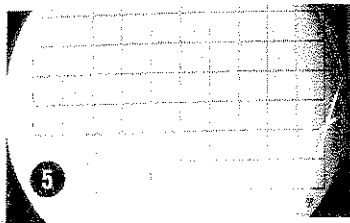

TEST POINTS	OSCILLOSCOPE SETTINGS	
	VERTICAL	HORIZONTAL
5 7 8	20 mV/cm (use 10:1 probe)	200 μs/cm
6	2 mV/cm (use 10:1 probe)	
9 10	20 mV/cm	
11 12 13	0.5 V/cm	
14 15	2V/cm	
16	5V/cm	
COMMON WAVEFORMS: FIGURE 8-4 (1kHz OSCILLATOR), 4. SEE PAGE 5-12 FOR MEASUREMENT PROCEDURE.		

A400 DETECTOR ASSEMBLY (04250-7724)

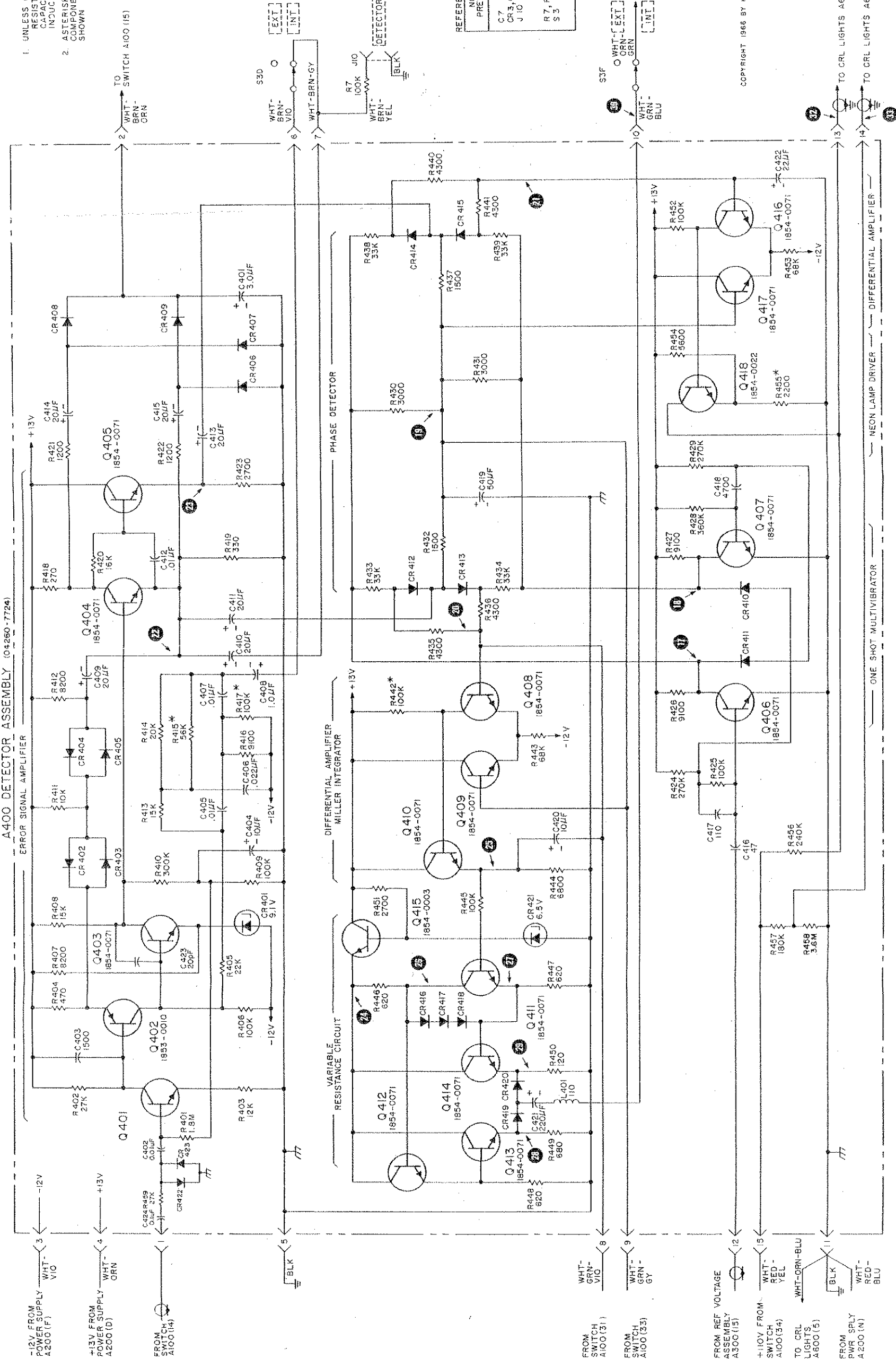

NO	DESIGNATION	A400
C 7	CR 3, CR 4	C 401-424
J 10		CR 401-423
R 7, R 8		L 401
S 3		G 401-418
		R 401-459

COPYRIGHT 1966 BY HEWLETT-PACKARD COMPANY

Figure 8-6. Detector Assembly A400
8-11/8-12

- NOTES
- UNLESS OTHERWISE INDICATED:
RESISTANCE IN OHMS;
CAPACITANCE IN MICROFARADS;
INDUCTANCE IN MICRORHENRIES
 - ASTERISK (*) INDICATES SELECTED COMPONENT, AVERAGE VALUES SHOWN